

TRUFROST & BUTLER

USER MANUAL

High Speed Oven

FIT Lite

PRÁTICA

SPEED OVEN



CUSTOMER LETTER

For us, your choice of a Prática product is a reason for great satisfaction.

This reinforces the meaning of our mission, which is to bring quality and productivity to the food preparation environment with the purpose of providing conditions for the preparation of good, quality food without waste.

To that end, our products offer high technology and the best quality standards. They are developed by an experienced and highly qualified team, and produced in a manufacturing plant with the most advanced processes and equipment.

Prática offers complete solutions to the whole food preparation chain. From bakery products to the entire culinary universe. From pre-prep to conservation, finishing and decoration. Prática offers a wide range of baking machines, deep-freezing and conservation equipment, and a wide range of ovens for baking, cooking, and quick finishing, as well as a full range of diverse accessories.

We hope that our products, accessories and pre- and post-sale services can be valuable tools for the success of your business and the continuity of our partnership.

Thank you.

This manual contains all the information you need to install and use your equipment correctly and achieve the best results in performance, quality and safety.

We recommend that you read and follow all guidelines contained therein and keep it in a suitable place for future reference at all times.

CONTENTS

IMPORTANT SAFETY INSTRUCTIONS

Recommendations For Use.....	08
Use Restrictions.....	10
General Cleaning Recommendations.....	10
Safety Risk: Cleaning Chemicals.....	11
Safety Risk: Heating.....	11
Safety Risk: Electrical Power.....	12
Suitable Utensils.....	13
Combination of Suitable Utensils.....	13

PRECAUTIONS TO AVOID POTENTIAL EXPOSURE TO EXCESSIVE MICROWAVE ENERGY.....

14

IDENTIFICATION OF SYMBOLS USED IN THIS MANUAL.....

15

WARRANTY

Term and Details.....	16
Reasons to Void a Warranty.....	17
Notes and Recommendations.....	18

INSTALLATION INSTRUCTIONS

Electrical Installation.....	19
General Instructions.....	21
Dimensions.....	22
General Recommendations.....	23

FIT LITE TECHNOLOGY.....

24

OPERATING PRINCIPLES.....

25

RECIPE CREATION.....

27

OPERATING INSTRUCTIONS

Pre-heating.....	28
Executing a recipe.....	29
Accessing the Options.....	32
User Settings.....	33
• <i>Edit Groups</i>	34
• <i>Edit Group Name</i>	35
• <i>Edit group icon</i>	36
• <i>Delete recipes in a group</i>	37

OPERATING INSTRUCTIONS

- *Delete Group*..... 38
- *Arrange Group*..... 39
- *Set Group Temperature*..... 40
- *Edit Recipes*..... 40
- *Edit Recipe Name*..... 42
- *Edit Recipe Image*..... 43
- *Edit recipe steps*..... 44
- *Delete Recipe*..... 47
- *Arrange Recipes*..... 48
- *Cook/Brown More*..... 49
- *Add/Remove Favorites*..... 50
- *Pre-heat*..... 52
- *Current temperature*..... 53
- *Celsius/Fahrenheit*..... 53
- *USB*..... 54
- *Export Menu*..... 57

System..... **57**

- *Language*..... 58
- *Date/Time*..... 58
- *Change Password*..... 59
- *Restore Original Settings*..... 60
- *Edit Access*..... 60
- *Information from the Manufacturer*..... 62
- *System Update*..... 63
- *Volume*..... 64

- Favorites..... 65
- Sound alarms..... 65
- Manual Mode..... 66

CLEANING

- Daily Cleaning Procedure Guide..... 69
- Catalytic Converter Cleaning Guide..... 75
- Air Filter Cleaning Guide..... 78

ALERTS AND ERRORS: POSSIBLE SOLUTIONS

- Alerts..... 80
- Errors..... 81
- Table of Alerts and Errors..... 82

IMPORTANT SAFETY INSTRUCTIONS

RECOMMENDATIONS FOR USE

- Oven operation: It is recommended that the oven operator always wear thermal protective gloves and aprons (PPEs) to avoid burns caused by hot internal parts of the oven and from any spillage of tray contents.
- Using the Dashboard: The panel should only be operated with your fingers, and the use of any instrument may damage the equipment and put the safety operator at risk.
- This equipment uses a catalytic filter that can be removed by the operator for cleaning.

CAUTION: To avoid burns, do not use containers loaded with liquids or kitchen products that become liquid by heating at levels higher than can be easily observed. **The sticker (as shown aside) is attached to the manual and must be inserted in the front when installing the equipment at a minimum height of 5.2 ft / 1,60m above the floor.**



- Read all instructions before using the equipment.
- Read and follow the specific PRECAUTIONS TO AVOID POSSIBLE EXPOSURE TO EXCESSIVE MICROWAVE ENERGY found on **page 14**.
- This equipment must be grounded. Connect only to properly grounded outlet. See GROUNDING INSTRUCTIONS found on **page 20**.
- Install or locate this equipment only in accordance with the provided installation instructions.
- Some products such as whole eggs and sealed containers – for example, closed glass jars – can explode and should not be heated in this oven.
- Use this equipment only for the functions described in this manual.
- **WARNING:** Do not use corrosive chemicals or vapours in this device. This type of oven is specifically designed to heat, regenerate, gratin, or finish food that has already undergone some cooking process. Not suitable for cooking food or products in general. It is not designed for industrial or laboratory use.
- **HOT CONTENTS CAN CAUSE SEVERE BURNS. DO NOT ALLOW CHILDREN TO USE THE MICROWAVE.** Use caution when removing hot items.

- **CAUTION: Do not use Speed Ovens to prepare food classified as “raw proteins,” chicken skin, raw bacon, raw burger, etc. This can damage the catalytic converter and void the warranty.**
- **CAUTION: Failure to maintain the equipment in clean condition may lead to surface deterioration, which may adversely affect the life of the equipment and possibly result in a hazardous situation.**
- Remove wires used to close paper or plastic bags that will be inserted into the oven. Do not use plastic utensils.
- It is recommended that children be supervised to ensure they do not play with the equipment.
- Do not operate the oven if it is damaged or if the oven door does not close properly.
- Do not place any objects between the door and the oven stop.
- Do not use water jet for cleaning.
- Do not clean this equipment with a steam cleaner.
- The oven shall have a dedicated circuit breaker.
- Do not wet the power cord or socket.
- Keep the power cord away from heated surfaces.
- If the power cord is damaged, it shall be replaced by the manufacturer, authorized technician, or a qualified person in order to avoid hazards.
- Only authorized technicians should open the equipment panel.
- Do not use plastic utensils.
- Do not use the microwave function without food inside. This may damage the equipment.
- Do not operate the equipment with the door open as this may result in exposure to microwave energy.
- Do not allow food residues or other debris to build up on the door surface and the hinge so as not to impair the oven seal.
- Foods with skin, peel, or membrane, such as: tomatoes, potatoes, sausages, and peppers shall be pierced with a fork before being put inside the oven, as they may explode.
- Check the temperature of heated food before serving to avoid burns.
- Shake and check the temperature of the contents of baby feeding bottles and bowls before consumption to avoid burns.

- Fully closed packages should not be heated in the oven, as they may explode.
- Minimum clearance above the microwave oven should be 5.9 in /150mm ***In the case of ovens that allow stacking (1+1), this distance should be measured from the top oven.***
- The oven shall be cleaned on a daily basis and any food build-up must be removed.
- When heating liquids using only microwave or a combined function, the contents should be stirred to prevent eruptive boiling. Heating beverages in the microwave oven may result in delayed eruption, therefore care should be taken when handling the container.
- Remove any excess fat after cooking/roasting/processing and before lifting heavy containers from the oven.
- When heating food in paper containers, pay attention to the oven due to the possibility of combustion/ignition.
- Food in combustible paper or plastic containers shall be transferred to a microwave-proof container that withstands the pre-heating temperature, to avoid the possibility of combustion/ignition.
- If glass breaks inside the oven, discard the food that was in the oven at the time of the breakage.

RESTRICTIONS OF USE

- Use only utensils suitable for use in microwave ovens as per **page 13**.
- Never use the equipment to heat alcohol, brandy, rum, etc.
- Alcohol can catch fire more easily if overheated. Use caution and do not leave the equipment unattended.
- If smoke is observed: Turn the equipment off. Disconnect or insulate from power and keep the door closed to smother the flames.

GENERAL CLEANING RECOMMENDATIONS

- The equipment's cooking chamber shall be cleaned on a daily basis. Failure to maintain the equipment daily schedule lead to surface deterioration, which may adversely affect the life of the equipment and possibly result in a hazardous situation.
- The equipment shall be disconnected from the mains during maintenance and parts replacement. It is not necessary to disconnect the equipment from the power supply during the daily cleaning.

- Perform daily oven cleaning according to the instructions on **page 74**.
- Perform air filter cleaning according to the instructions on **page 80**.
- Perform catalytic filter cleaning according to the instructions on **page 80**.
- Prática recommends a technical inspection of the equipment by an **authorized technician every 6 months**.

Prática's Legal Representative

Eigelstein 103-113, BAG Business Center – 50668 Köln – Germany
 Phone +49-1515-8753646 / E-mail: contact@practicaeurope.com

SAFETY RISK: CLEANING CHEMICALS

DANGER	WHERE OR IN WHAT SITUATIONS DOES THE DANGER ARISE?	PREVENTIVE ACTION
<p>There is risk of chemical burns or irritation of the skin, eyes and respiratory system due to contact with cleaning chemicals and their fumes.</p>	<p>For all cleaning actions.</p>	<ul style="list-style-type: none"> •Do not allow cleaning chemicals to come in contact with your skin or eyes. •Do not heat the equipment if cleaning chemicals are inside. •Do not breathe the chemical spray. •Wear personal protective equipment (PPE). <hr/> <ul style="list-style-type: none"> •Strictly follow the steps for cleaning, as per Daily Cleaning topic.

SAFETY RISK: HEATING

DANGER	WHERE OR IN WHAT SITUATIONS DOES THE DANGER ARISE?	PREVENTIVE ACTION
<p>There is risk of burns from hot surfaces.</p>	<p>Within the entire chamber, including all parts that are or were inside during cooking, such as:</p> <ul style="list-style-type: none"> •Racks; •Containers; •Roasting pans. <hr/> <p>On the inside of the equipment door.</p>	<p>•Before starting the cleaning tasks, wait until the chamber has cooled below 50°C / 122°F.</p> <hr/> <p>Wear personal protective clothing and equipment (PPE) as instructed in page 08.</p>

SAFETY RISK: ELECTRICAL POWER

DANGER	WHERE OR IN WHAT SITUATIONS DOES THE DANGER ARISE?	PREVENTIVE ACTION
<p>There is risk of electric shock from energized parts.</p>	<ul style="list-style-type: none"> •Below the side and top panels; •In the display panel; •Along the power cord. 	<ul style="list-style-type: none"> •Any work on the electrical system should be performed only by qualified electricians from an authorized service company. •Make sure that all electrical connections are in perfect condition and secure before putting the equipment into use.
	<p>On the equipment and adjacent metal parts.</p>	<ul style="list-style-type: none"> •Before preparing the equipment for use, make sure that the equipment is connected to an equipotential offset system (EU).
	<p>If the equipment on wheeled supports starts to move accidentally and the power supply is switched off.</p>	<ul style="list-style-type: none"> •When operating the equipment, always engage the safety lock on the wheels. •Check if the wheel locks are engaged on a daily basis before starting operation.
<p>Risk of electric shock caused by a short circuit.</p>	<p>If the equipment comes in contact with water.</p>	<ul style="list-style-type: none"> •Do not flush the outer box with water. •Always keep the USB cover closed during cleaning.

USAGE RISK

USE	WHERE OR IN WHAT SITUATIONS DOES THE DANGER ARISE?	PREVENTIVE ACTION
<p>The use of the speed grill is mandatory.</p>	<p>Failure to use the speed grill will damage the oven and require technical intervention.</p>	<p>Always use the speed grill.</p>
<p>Do not use plastic items.</p>	<p>Fire hazard.</p>	<p>In case of fire, keep the door closed to extinguish the flames.</p>
<p>Do not use paper items.</p>		
<p>Do not operate the oven if the door has any damage or does not close properly.</p>	<p>Risk to user.</p>	<p>Technical intervention required.</p>

SUITABLE UTENSILS

Check the manufacturer's instructions and the temperature rating to determine the suitability of individual containers and accessories for use with the oven. The table below provides general guidelines:

SUITABLE COOKWARE	ALLOWED	PREVENTIVE ACTION
HEAT-RESISTANT CONTAINERS		
Tempered glass.	YES	
Compatible ceramics.		Do not use items with metallic decoration.
Clayware (china, etc.) Note: The content of mineral in the utensil may affect the performance of the equipment.		
SHEET AND METAL TRAYS		
Any metal or foil containers.	NO	
PLASTIC CONTAINERS		
Plastic containers.	NO	
DISPOSABLES		
Fuels (paper, cardboard, etc.).	YES	Use only disposables suited to the temperatures reached by the oven (280°C / 536°F).
OTHER UTENSILS		
Ties and labels.	NO	During the cooking process, no tools such as probes, cutlery, ties and labels should be inside the oven.
Cutlery.		
Temperature probes.		

COMBINATION OF SUITABLE UTENSILS

COMBINATION OF SUITABLE UTENSILS	ALLOWED
Speed Grill	YES
Speed Grill + Solid Ptfе Basket	YES
Speed Grill + Wave Tray	YES
Teflon accessories	YES

CAUTION!

- This equipment can be used by children aged from 8 years and above and persons with reduced physical, sensory or mental capabilities or lack of experience and knowledge if they have been given supervision or instruction concerning use of the appliance in a safe way and understand the hazards involved.



- Do not use the oven handle to move the equipment. Only move the oven by its sides.



- Do not use the equipment door as a support. This will cause the door to become uneven and the equipment to malfunction.



- Using the door for any other purpose than those described herein may result in voiding the warranty.



- This equipment is intended for use in commercial applications – not for continuous mass food production.

PRECAUTIONS TO AVOID POTENTIAL EXPOSURE TO EXCESSIVE MICROWAVE ENERGY

(a) Do not attempt to operate this oven with the door open, as it may result in harmful exposure to microwave energy. It is important to not override or manipulate the safety interlocks.

(b) Do not place any objects between the front face of the oven and the door, or allow dirt or cleaning residues to build up on the sealing surfaces.

(c) Do not use the oven if it is damaged. It is particularly important that the oven door closes properly and that there is no damage to the: (1) Door (tilted); (2) Hinges and latches (broken or loose); (3) Door seals and sealing surfaces.

(d) The oven shall not be adjusted or repaired by any person other than qualified service personnel.

(e) **WARNING:** It is hazardous for anyone other than a competent person to carry out any service or repair operation that involves the removal of any cover which gives protection against exposure to microwave energy (IEC 60335-2-90.2015).

IDENTIFICATION OF SYMBOLS USED IN THIS MANUAL



DANGER! RISK THAT MAY CAUSE SERIOUS INJURY OR DEATH



ALERT



FIRE HAZARD



MICROWAVE SYMBOL



ELECTRICAL SHOCK HAZARD



BURN HAZARD



RISK OF BURN BY HOT LOAD SPILL



GROUNDING SYMBOL



EQUIPOTENTIAL SYMBOL



TIPS AND INFORMATION ABOUT USE

WARRANTY

TERMS AND DETAILING

- a)** Our products are warranted for twelve months for parts and labor and twenty-four months for all heating element parts; from the date the product is installed. If, for any reason, there is no record of the installation date or the purchase invoice is not found, the date of manufacture of the equipment printed on the indicative label will be considered the date of the applicability of this guarantee.
- b)** If new visits are needed to complete the delivery/installation of the product due to the lack of adequate, electrical, or exhaust related conditions, the costs of such visits shall be the customer's responsibility.
- c)** For the appliance's installation, the customer must provide all conditions required (220v, 230v, 208v/240v, 380v, and 400v single/multi phase) in the installation blueprint. The customer will also be responsible for transporting the equipment to the installation site.
- d)** The warranty only covers manufacturing and component failures. Damages caused by lack of heeding to label warnings on the product will not be covered.
- e)** The warranty will cover adjustments and replacement of defective parts. It is the responsibility of the authorized service technician to return the defective parts to Pratica Inc. for analysis when requested by the Manufacturer.
- f)** Warranty service calls will not justify the extent of the warranty, returns or exchanges of the equipment, or any other type of claim.

WARRANTY EXCLUSIONS

- a) The customer should thoroughly inspect the equipment upon delivery and contact the carrier in case of shipping damage arising from transport.
- b) Prática will not respond to any issues arising from electrical building irregularities, or a lack of abiding to the local electrical code. These issues will not be covered by the Warranty.
- c) Use or installation not in accordance with the Installation and Operation Manual accompanying the product.
- d) Failure to observe the installation details per the Installation and Operation Manual, such as uneven floors, installing the oven next to equipment that produces fat, heat, or solid particles, lack of air circulation, etc.
- e) Any damage done to the oven or it's components resulting from the use of inappropriate cleaning products or methods will not be covered under the warranty. For example, pouring water inside the electric panel, etc.
- f) Changes performed by unauthorized technicians in the original conditions of installation such as electrical distribution, installation location, etc.
- g) Use of aggressive or abrasive products that are unsuitable for cleaning which may tarnish, wear, scratch, or damage accessories or equipment components.
- h) Occurrences of electrical discharges arising from acts of nature or voltage peaks caused by generators or power supply companies.
- i) Damage to the equipment or its accessories caused by accidents, improper operation, and improper handling or installation as described by the Operation Manual included with this product.
- j) Repair attempts by unauthorized third parties or use of non-OEM parts and components, regardless of the damage or defects.

NOTES AND RECOMMENDATIONS

- a) The operator should use the Installation and Operation Manual as a guide.
- b) Make sure that the electric systems are made and installed by a qualified company or technician.
- c) Before contacting technical assistance, check the manual for troubleshooting tips that can be solved without a technician. Always remember that Pratica must be contacted first before getting in contact with service agent.
- d) To contact our customer service team and share your comments and suggestions, please call: **+55 (35) 3449-1235** or email: **comex@praticabr.com**

EQUIPMENT ID
(complete to facilitate technical calls)

MODEL: _____ VOLTAGE: _____
SERIAL #: _____ RESELLER: _____
TAX NOTE #: _____ PURCHASE DATE: _____

INSTALLATION INSTRUCTIONS

ELECTRICAL INSTALLATION

- Always follow the installation recommendations in the instruction manual or the product spec sheet. The spec sheet is attached to the manual, and it is sent by email at the time of approval of your order, and is also available on our website (www.praticabr.com). If you have any questions, please contact Prática's Helpdesk:

You may contact us via:

Phone: +55 (35) 3449-1235

Email: comex@praticabr.com

- All Prática ovens shall be installed with the required care to avoid problems and damages to the equipment and ensure its full use.

- This equipment shall be installed by an authorized technician.

- Grounding the oven is mandatory.



- Do not wet the power cord or socket.

- Keep the power cord away from heated surfaces.



- If the power cord is damaged, it shall be replaced only by authorized service personnel.

- Only authorized technicians should open the equipment panel.

FIT LITE (Note: The Fit Lite is not for frozen products)								
Region	Voltage (V)	Phases	Freq. (Hz)	Power (kW)	*Circuit Breaker (A)	Cable	Socket	
United Kingdom	230	Single	50	3	13	3x1,5 mm ²	13A (2P+E)	NOT PROVIDED
Europe	230	Single	50	3.4	16	3x2.5 mm ²	16A (2P+E)	NOT PROVIDED
	230	Single	50	3.4	16	3x2.5 mm ²	16A (2P+E)	

*Prática recommends installing a type D circuit breaker. The electrical installation must comply with local regulations.

INSTALLATION INSTRUCTIONS

Note: The equipment has an equipotential point connector for other equipment. Such connector aims to maintain multiple equipment with the same electrical power. It is not necessarily the grounding of a local connection. This connector is located on the back of the equipment and is identified with the following symbol.



Note: the oven must to be mounted only above countertop level.

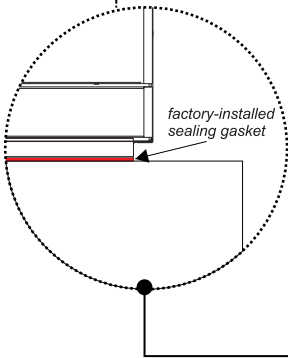
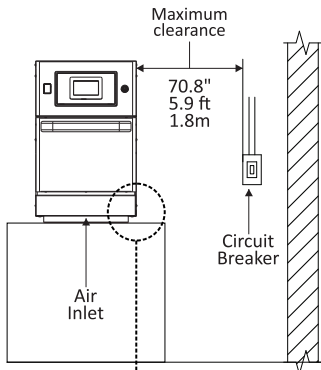

- It is recommended to use the cable gland to prevent movement of the power cable.
- If the oven voltage is 380 volts, a neutral cable shall be used (irrespective of grounding).
- Make sure that the electrical characteristics of the building comply with the specifications on the label located on the back of the equipment. The building's electrical installation is the responsibility of the customer.
- This unit shall be properly grounded to prevent electric shocks.
- The circuit breaker shall be located no more than 70.8" / 5.9 ft / 1.8m from the equipment.
- To meet the sanitary operating requirements, the equipment must be installed on a completely flat surface, with proper sealing between the oven and this surface.
- The equipment has a flat base and a factory-installed sealing gasket. No additional materials are needed to ensure the seal between the equipment and the counter. The only requirement is that the counter be absolutely flat.

GENERAL INSTRUCTIONS

- The oven shall be installed on a base or counter that supports its weight, approximately 123.4lbs (56 Kg).
- Do not obstruct the side air inlet and rear air outlet.
- The oven should not be positioned next to stoves, fryers, hot grills or other equipment that release grease, vapors and heat. Ventilation, electrical panel, and motor outlets shall be clear of these heat sources to prevent damage to the equipment's electrical system.
- The oven shall be installed in a level and ventilated place.
- Failure to install the equipment in an appropriate location may result in voiding the warranty.

INSTALLATION INSTRUCTIONS

DIMENSIONS

FIT LITE

FRONT VIEW

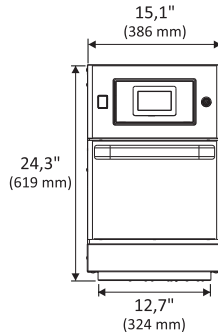

SIDE VIEW

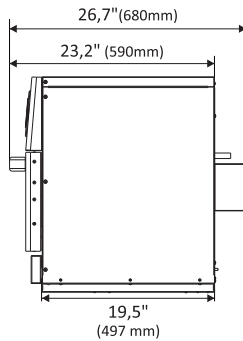

SIDE VIEW
WITH DOOR OPEN

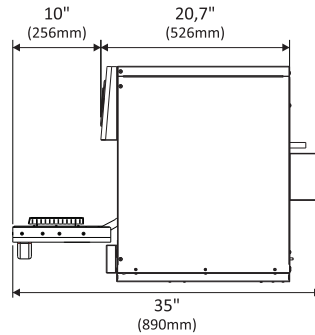

Chamber size	
Payload	13L - 0.45 cu.ft
Height	6.6" - 170mm -
Width	12.4" - 315mm -
Depth	13.4" - 341mm -

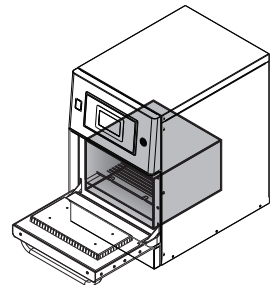

GENERAL RECOMMENDATIONS



- Do not use this product near sources of water such as sinks or pools, or in very wet locations.



- If residues accumulated inside the oven goes into combustion, keep the oven door closed, cut the power supply to the oven by turning off the oven's dedicated circuit breaker and unplug the oven from the socket.



- Do not use the oven to dry clothes or store utensils.



- Do not operate the oven door if it is damaged until it is repaired by a qualified person.

- If the power supply cuts off while the oven is in use, the food in preparation will be lost (saved recipes/oven information will not be lost).
- Do not cover or block any equipment's vent.
- Do not use the oven outdoors, which are exposed to time without shelter.
- Do not store food inside the oven when it is not in operation.
- Wait ten seconds to turn the oven on after starting the circuit breaker.



Attention: Whenever the oven is in operation, the **Speed Grill** must be correctly installed in the oven in its operating position.



Operating the oven without the **Speed Grill** may result in damage to the equipment, requiring technical service repair.

Speed Grill in its operating position

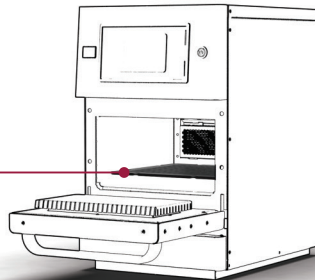

FIT LITE TECHNOLOGY

The **Fit Lite** oven uses a combination of heating by high-speed impinged air and microwave energy to heat food faster than conventional methods.

The figure below illustrates how the technology works.

- 1) **Magnetrons** generate energy through the microwaves, which uniformly heat the water molecules in the food;
- 2) **Internal heater resistances** transfer thermal energy to the circulating air;
- 3) The **stirrer** distributes the microwaves evenly;
- 4) The **impinged air** is directed to the food;
- 5) The **catalytic converter** leads the volatile organic compounds into carbon dioxide and water (CO₂ and H₂O);
- 6) The **blower motor** circulates air at high speed;
- 7) In parallel to all this, the **microwaves** penetrate the food to heat it.

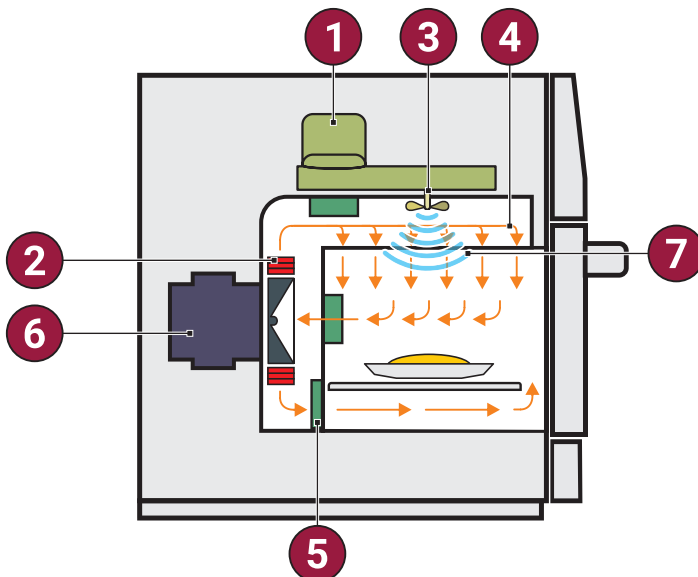

OPERATING PRINCIPLES

Microwaves are a type of radiant energy. Like radio waves, visible light, and infrared, microwaves are part of the electromagnetic spectrum, that is, it is a form of electromagnetic radiation. They are classified as non-ionizing radiation because unlike X-rays and Alpha, Beta and Gamma rays, their effects are strictly thermal and, therefore, do not alter the molecular structure of the item receiving them.

The basic principle of microwaves is cooking by molecular vibration. They penetrate food superficially, to a depth ranging from 0.7" (20mm) to 2.7" (70mm), and heat the food by vibrating the water, fat, and sugar molecules in it. Heat is transmitted into the food by thermal conduction, demystifying the idea created that microwaves cooked food from the inside out.

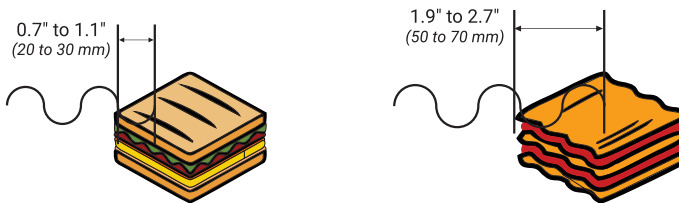

Fit Lite works by associating microwaves with hot air, which are directed to the food. The variables in the operation are the following:

- a) Operating time;
- b) Chamber temperature;
- c) Microwave power;
- d) Air speed.

Each scheduled operation (recipe) may be composed of eight steps and the variables mentioned above are included in each step.

Temperatures: Be aware that preparation times and their steps are short, so it is not possible to note clearly when the temperature changes in the chamber from one step to another or from one recipe to another. The temperature applied by the oven will be the one which the preheat was set up to, and the equipment is activated to maintain the preheat temperature between functions.

Microwave: Adjustable between 0% and 100% at every 30 seconds. E.g. for a 1 minute long recipe, with the microwaves programmed at 50%, they will have an effect on the food for 15 seconds, then they will stop for another 15 seconds and repeat this process in the next 30 seconds. That is, in 1 minute, they will run for 30 seconds. Microwaves have the function of heating food and do not require a specific means to propagate.

They are reflected by metals, but go through glass, plastics, and ceramics easily, and act on food by penetrating it.

CHARACTERISTICS

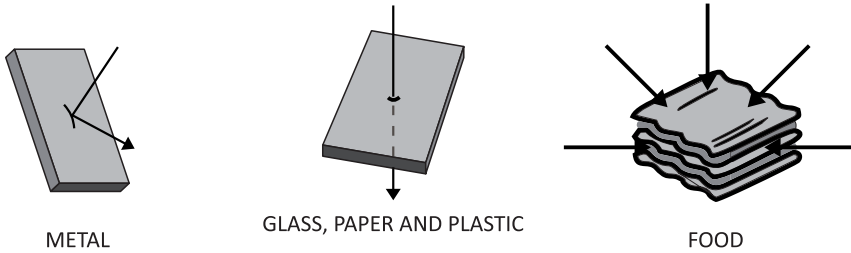

Plastic containers shall not be used in the **Fit Lite** as these will incinerate with the heating of the chamber (**see more on proper utensils on page 13**).

Operating time: The microwave oven heats food from the outside in, and penetration rates will change according to the food composition. Therefore, we must calculate the time of preparation considering the food composition, the amount of food processed, and its density and thickness. The higher the quantity, density and thickness, the longer will be the time required for microwaves to act inside the food.

Hot air speed: The hot air directed over the food will be adjusted between 0% and 100% of the total speed. It is also responsible for the transmission of heat to food, although its main function is related to:

a) The external aspect of the food, that is, its color. The higher the air speed, the darker (golden) the food will become;

b) The texture or crunch. The higher the air speed, the greater will be the removal of water from the food surface, increasing its crunchiness.

RECIPE CREATION

When developing a recipe, all of the above variables should be factored in. Microwaves and air speed are the key components to a successful preparation.

At first, it is necessary to work only with the microwaves to reach the food's internal temperature. The microwave effect is more efficient early in the process. For frozen products, perform two- or three-step operations so that at the beginning, the product is defrosted with lower microwave levels and at the end of the process, the optimal color and crunchiness is obtained.

Later, combine the variations of the hot air speed to get the desired finish in terms of color and crunchiness. Remember that these variables also transmit heat to food.

Food weight, size and shape are key to the total preparation time.

After defining how the food will be prepared, it is critical to know that:

- a) The initial temperature variation of the food (frozen, cooled or at room temperature) will change the desired final product;*
- b) The variation in the size or weight of the serving will also produce a food outside the standard established in the recipe;*
- c) Considering that different materials will have different reactions with microwaves, changing the cooking utensil will interfere with the product's final aspect.*

OPERATING INSTRUCTIONS

After startup, choose your preferred language. See more about languages on page 61.

PRE-HEATING

a) **Fit Lite** has two groups of pre-heating setups that can be used according to the need of each user or application.

Example:

Pre-heat group 1 can be used for breakfast or sandwich recipes and **Pre-heat 2** can be used for recipes for a lunch or dinner menu. The main purpose of this function is to organize menus that require different pre-heating temperatures. This way, the oven will pre-heat as needed by the end user to serve the menu for each time of day.

CAUTION: Recipes created in **Pre-heat 1** will not be shown on **Pre-heat 2**. The same will happen for recipes created in **Pre-heat 2**, which will not appear in **Pre-heat 1**.

b) Turn on the equipment and choose between preheat groups 1 and 2.

c) The following screen will display the CURRENT temperature, the SCHEDULED pre-heating temperature. The orange bar is gradually filled as the oven temperature increases.

Note: the timer only starts when the CURRENT temperature reaches the SCHEDULED temperature, so that the oven temperature is uniform throughout the chamber (see more on preheat on page 52).

The temperature may be changed between **Celsius** and **Fahrenheit** according to user preference.

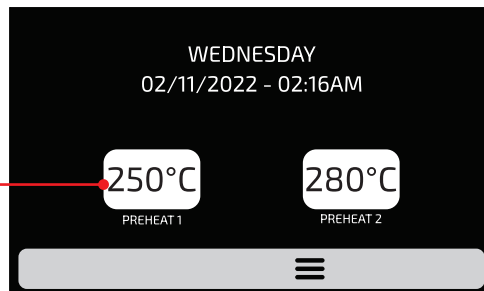

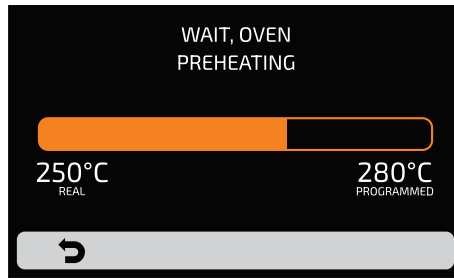

EXECUTING A RECIPE



ATTENTION: YOU MUST PROGRAM A RECIPE OR LOAD A SERIES OF RECIPES IN ORDER TO FOLLOW THE INSTRUCTIONS BELOW.

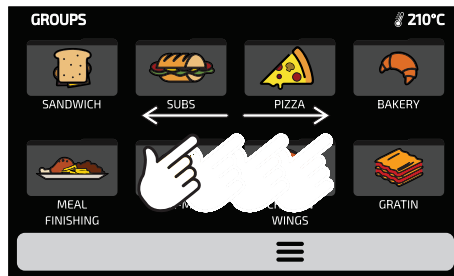

a) After pre-heating, select the desired GROUP. Swipe your finger  over the screen to view all groups.

Note: The screen will always roll vertically.

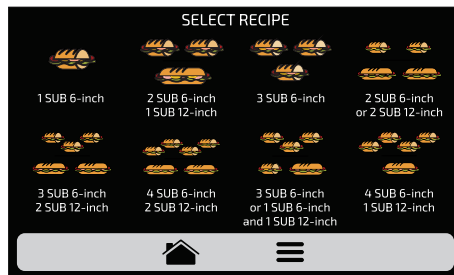

b) All RECIPES for the selected group will be displayed. Press on the desired recipe.



- To return to the GROUPS screen, press the button: .
- Swipe your finger  over the screen to view all available recipes.
- **Make sure you always have food inside the oven when running a recipe, otherwise it will cause damage to the equipment.**

c) The recipe will be executed immediately.

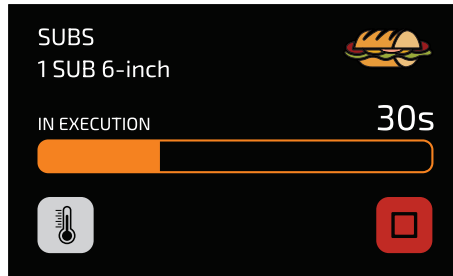

• The screen will display the group name, recipe name, operation status (in progress or paused) and the time remaining to complete the recipe.

d) It is possible to check the **CHAMBER ELEMENT** temperature by pressing the  button.

e) If you want to cancel the execution of a recipe, press the  button.

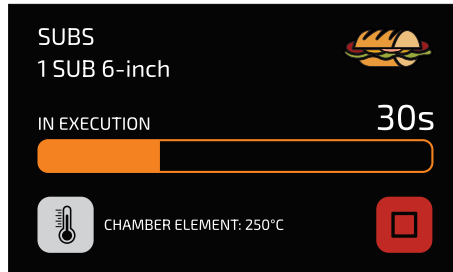

f) If the equipment's door is opened, the operation will be paused. After closing the door, the operation will resume by pressing the  button.

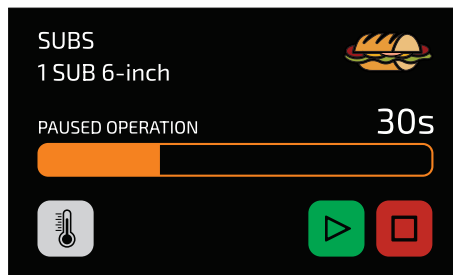

g) If the recipe programmer adds information in one of the steps, such as: "ADD TOMATOES," the recipe will be paused and the description of the information will be displayed next to the PLAY button, as shown in the image:

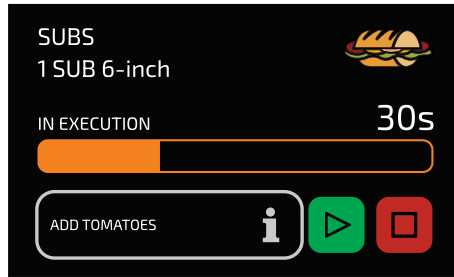

h) Press the  button to resume execution.

i) Upon completion of a recipe, the following options will be available:



Cook/Brown more: Activates the microwaves and hot air for the time pre-determined when the recipe was created.



Brown more: Only triggers hot air for the time predetermined when the recipe was created.



Cook more: Only triggers microwaves for the time predetermined when the recipe was created.



Repeat recipe: Repeats the same recipe chosen by the user.



- In "Cook/Brown more," "brown more" and "cook more" the time will be set at the time of creating the recipe.

- The four options mentioned above can be disabled so that they do not appear in any recipe. Learn more in the **User Settings block: Edit Access** (see page 60).

Example of brown more in action:

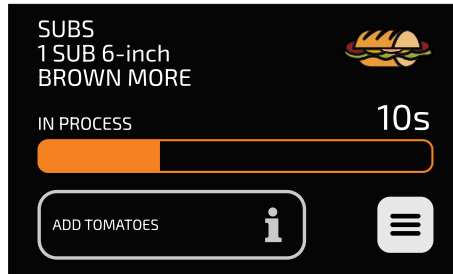

ACCESSING THE OPTIONS

a) To access the settings at any time, press the icon found in the fixed menu bar.

b) The options screen shows information such as: chamber's current temperature, manual mode, favorites, daily cleaning guide and settings.

Note: *Manual mode and favorites are only shown if enabled by the administrator (see page 60).*

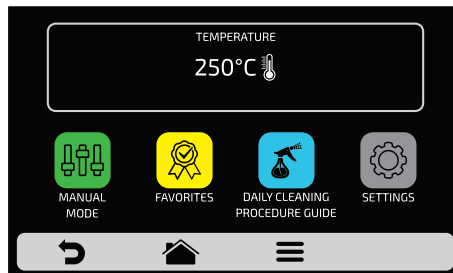

c) Pressing the icon again will return to the recipe group screen.

d) Pressing the icon will take you to the Pre-heating selection screen again.

USER SETTINGS

a) In the options screen, click the  icon. The screen to enter the user password will be displayed.

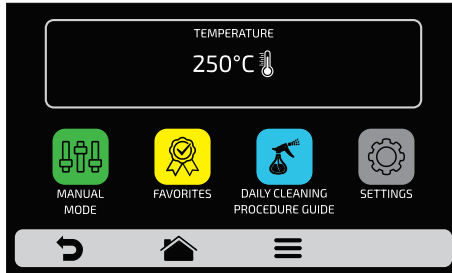

b) The default password for access to the settings is 456789. The password can be changed (*see page 59*).

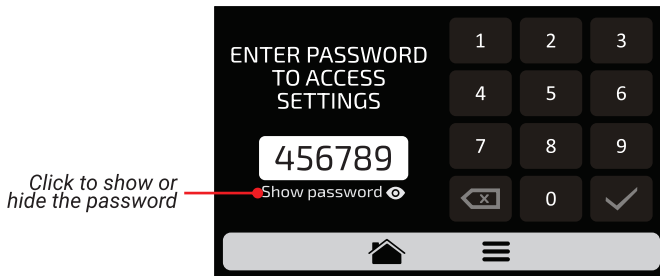

c) The user settings screen consists of the items below, and swipe your finger  over the screen to see more options. Please understand in detail each item on the following pages.

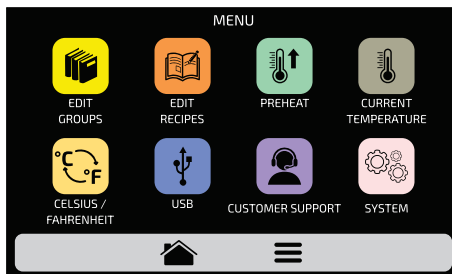

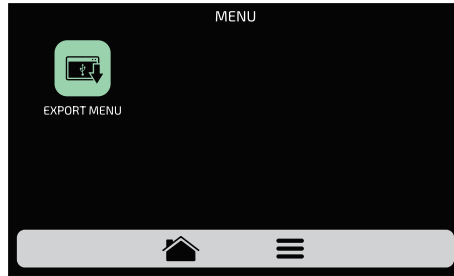



USER SETTINGS: EDIT GROUPS

Note: The oven has two pre-heating temperatures as shown on **page 28**. After pre-heating, the oven will show the recipes for the selected preheat group. Recipes configured in group 1 will only be available when **preheat 1** is executed, and the same applies to group 2.

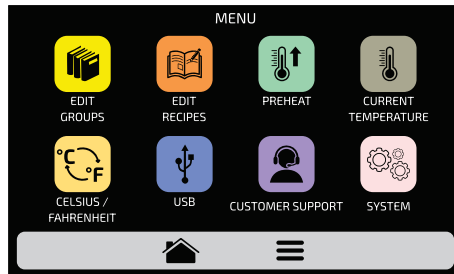
a) To edit groups, press the  icon and the groups screen will appear. The icon to create a new group will be at the top.



b) Create a new group or select an existing group that you want to edit. You can have up to 16 groups in total. Swipe your finger  over the screen to view all groups.

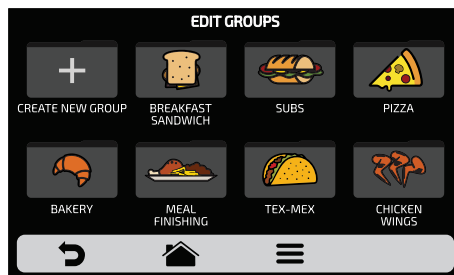

c) The options available after choosing between editing or creating a group are:

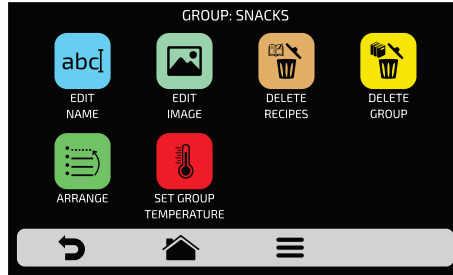

Edit Name: Changes the group name. You can use letters, numbers, or special characters.



Edit Image: Changes the image in the group icon.



Delete Group: Deletes all information for the selected group, including recipes.



Delete Recipes: Deletes previously selected recipes.



Arrange: Allows you to sort the location where the group appears among existing groups.



Set Group Temperature: Changes the group's pre-heating temperature. Note: recipes configured in group 1 will only be available when preheat 1 is selected, and the same applies to group 2.

EDIT GROUP NAME

a) Selecting the **edit name** option will display the following screen:





b) By clicking on **&123** and **ABC** (1/1 and 1/2) the screen will toggle between letters and numbers/special characters.



Deletes a character	Saves the name and returns to options

EDIT GROUP ICON

a) *Fit Lite* has an icon gallery that allows the user to exchange the images of their groups. Press the  icon.

b) A screen with the icon library will be displayed. Navigate through the groups and select the desired icon. You also can keep the first letter of the group name as an icon by clicking the **ABC** icon. Swipe your finger  over the screen to view all icons.

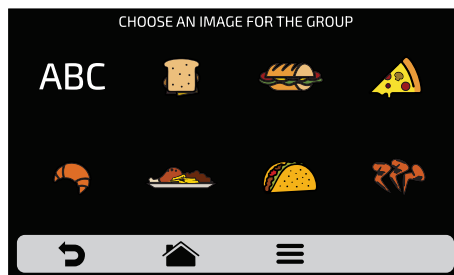



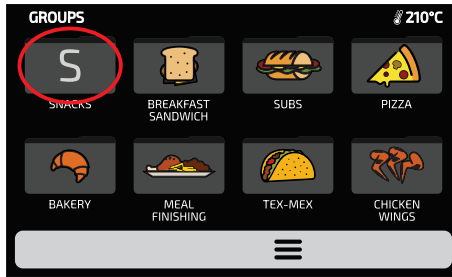

For example, if your group is called SNACKS, the icon for that group will be “S.”

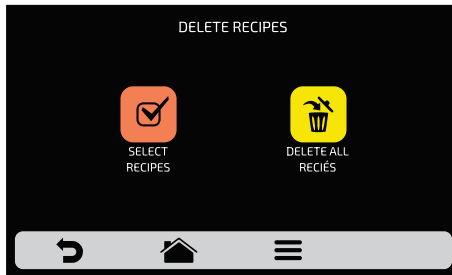

DELETE RECIPES IN A GROUP

a) The delete recipes option will only allow you to delete recipes from the previously selected group. Press the  button. You can delete a selection of recipes or all of them in the next screen.



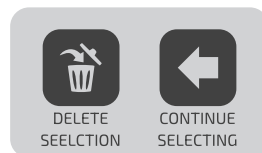
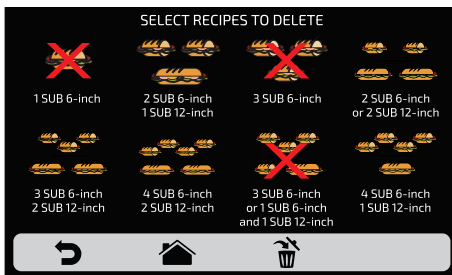

b) Select the recipes  you want to delete,  will indicate the ones selected, then click on the trash can on the  fixed bar.



A message will appear; to confirm the deletion of recipes, click on the “DELETE SELECTION” icon. Click on “CONTINUE SELECTING” to expand your selection.

c) The following message will appear after clicking on the  icon to delete all:





To confirm, click  or to cancel and return, click .

DELETE GROUP

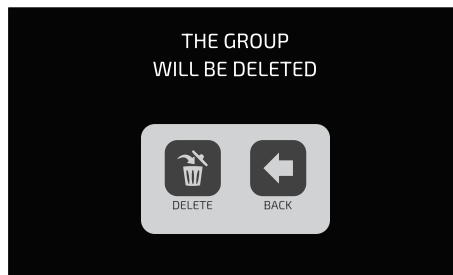
a) **CAUTION:** When choosing the option to delete the group, all information regarding the group will be lost: recipes, steps and other information. And if the user does not back up the information (**see page 54**) it will not be possible to retrieve this information.





b) Press the  button to confirm your choice or  to return to the options screen.

ARRANGE GROUP

a) The arrange function  allows you to change the sequence in which groups will appear on the screen.

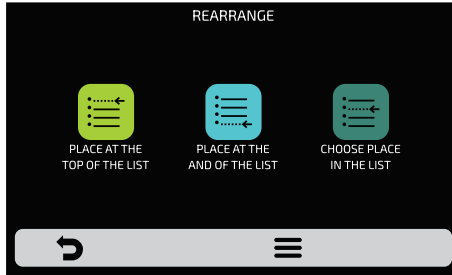
This screen consists of three buttons:



 **Place at the top of the list:** The group is moved to the beginning of the group list.

 **Place at the end of the list:** The group is moved to the end of the group list.

 **Choose place in the list:** The operator will be directed to the groups screen to choose the location they want in the list.

b) To change the position of a group, simply press on the group to select it and slide  to the desired position. Press  to save the change.

c) If the replacement is done horizontally (1-2, 3-4, 5-6 and 7-8) the two groups in question will change position without changing the order of the other groups, as shown in the image below:



d) If the substitution is done randomly, once the position is selected, the groups will be sorted sequentially (1, 2, 3, 4, 5, 6, 7, and 8), as shown in the image below:

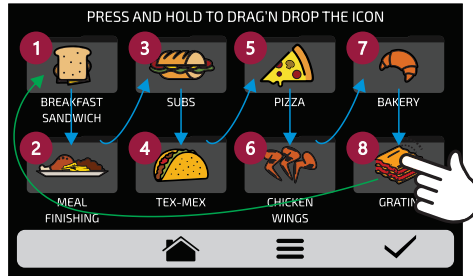



SET GROUP TEMPERATURE

a) Choose the desired pre-heat temperature for the selected group .

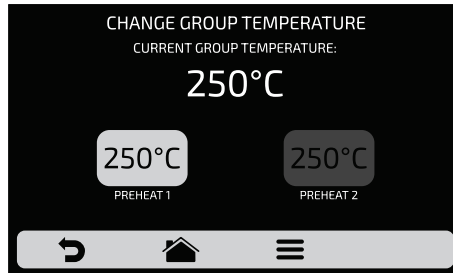
Note: Recipes configured in group 1 will only be available when preheat 1 is selected, and the same applies to group 2.



USER SETTINGS: EDIT RECIPES



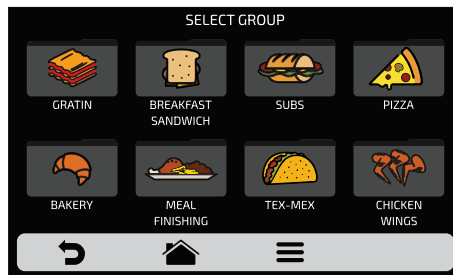

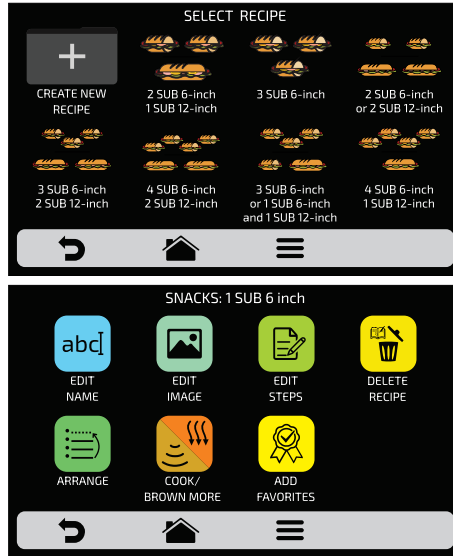

a) To edit recipes, press the  icon. The Groups screen will be available. Choose which group you want to change recipes for. Swipe your finger  over the screen to view all groups.



b) When accessing recipes, you can edit an existing one or create a new recipe.



The options available after choosing to edit or create a recipe are:

-  **Edit Name:** changes the name of the recipe by using letters, numbers or special characters.
-  **Edit image:** changes the image or icon that represents the recipe.
-  **Edit Steps:** accesses the step editing options for the selected recipe.
-  **Delete Recipe:** deletes all information for the selected recipe, including the steps.
-  **Arrange:** allows the change of a recipe's position among the other recipes in the group.
-  **Cook/Brown More:** changes the time of the heat/brown more function.
-  **Add/Remove Favorites:** adds or removes the recipe from the favorites list.

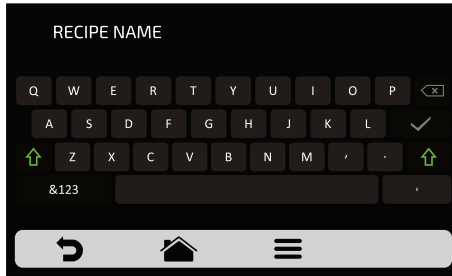

EDIT RECIPE NAME

a) Selecting the **edit name** option will display the following screen:

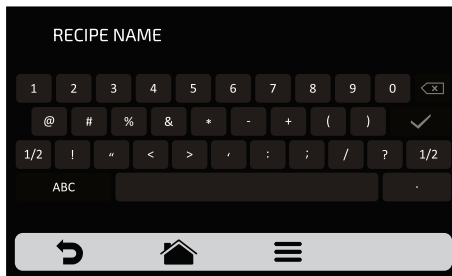

b) By clicking on **&123** and **ABC** (1/1 and 1/2) the screen will toggle between letters and numbers/special characters.



	
<p>Deletes a character</p>	<p>Saves the name and returns to options</p>

EDIT RECIPE IMAGE

a) **Fit Lite** has an image library that allows the user to change recipe icons/pictures. Press the  icon to edit and then choose between **ICONS** or **PICTURES** for the recipes displayed.

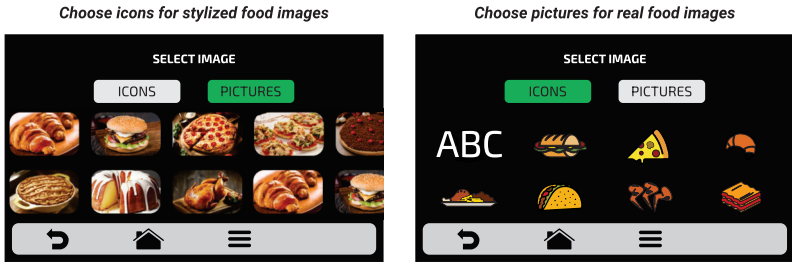

b) To access the next page of recipes, swipe your finger  over the screen to view all recipes.

c) Browse the image library groups to select the desired icon or press the **ABC** button to turn the first letter of the recipe name into an icon. As shown in the example below:

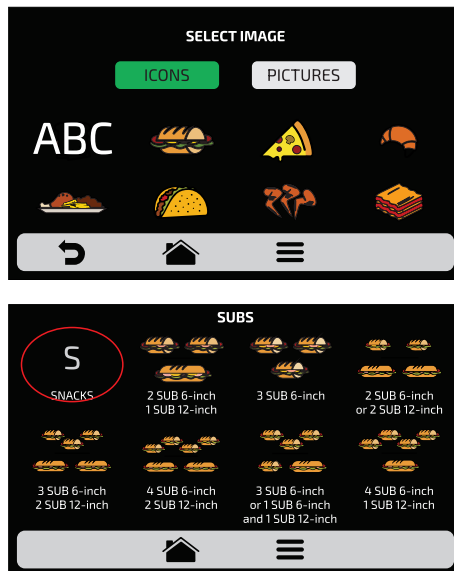

d) Use  to return to the recipe editing options

EDIT RECIPE STEPS

a) Each recipe can have up to 8 steps, and the active steps will appear in green on the editing screen. All other steps will be transparent, as shown below. Click on a step to edit it.

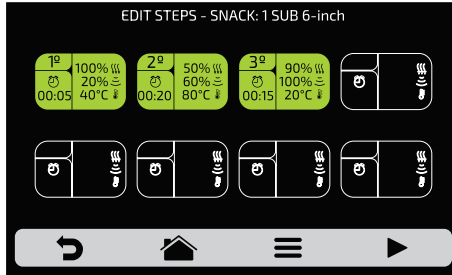

b) The following information is required for each step:

- 1 - Speed of hot air;
- 2 - Amount of microwaves (in %);
- 3 - Temperature;
- 4 - Amount of time.

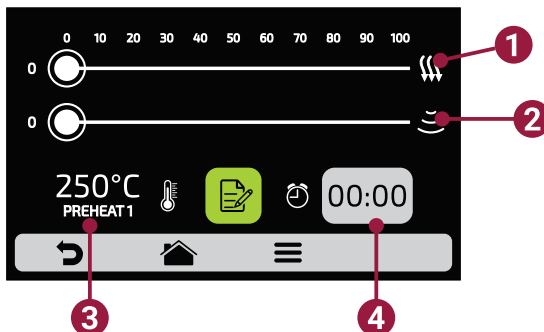

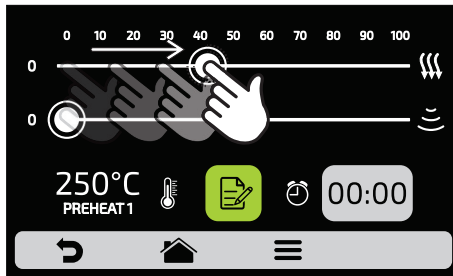
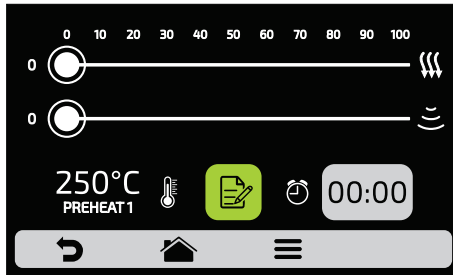

c) To change the speed of hot air and microwaves, simply drag your finger over the bar of each parameter or click on the desired location in the bar.



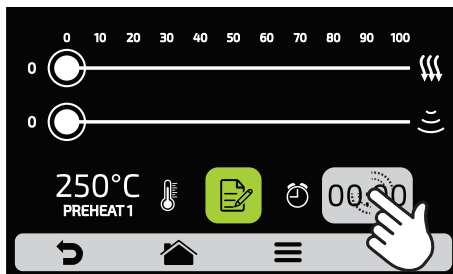

d) To set the time, click on the **00:00** icon. Using the keyboard that will appear on the opposite side, set the desired value and click ✓ .

e) To set the temperature, click the **250°C PREHEAT 1** icon. Using the keyboard will appear on the opposite side, set the desired value and click ✓ .

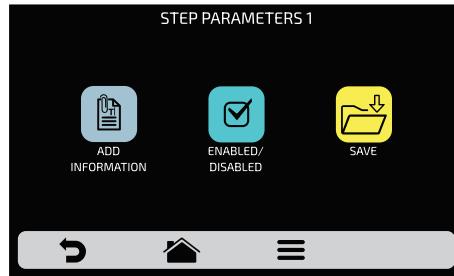

f) Click on the  button to access the options to edit the step parameters, which are:



g) To add information that will be displayed at the end of the step during the recipe execution. Click on the  icon.

h) Activate and inactivate the step:

- *Only the active steps of a recipe will be executed. An inactivated step is not deleted, only hidden.*
- *To delete the step, you must enter the 00:00 value for the time parameter.*





ENABLED



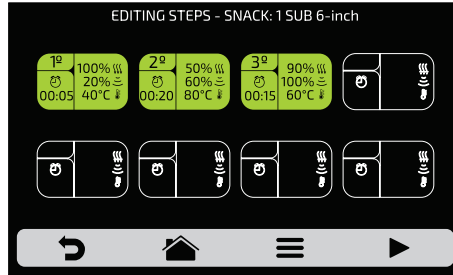

DISABLED

i) After you complete editing a step, use  to return to the steps screen and edit, create a new step, or test the active steps.



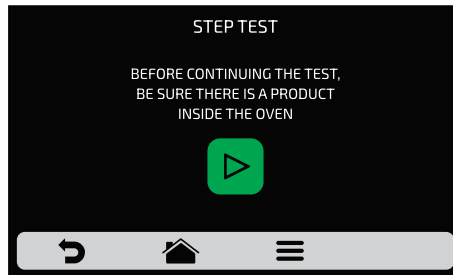

j) To test it, click on the  icon on the fixed bar of the steps screen. Before proceeding with the test, make sure there is food inside the chamber.



k) Use  to return to the recipe editing options.

DELETE RECIPE

a) Press  to delete the recipe and press the  button to confirm the deletion or  to return to the recipe editing options.

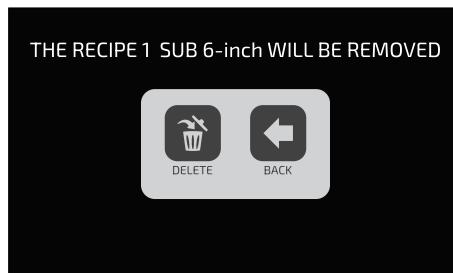

ARRANGE RECIPES

a) The arrange function  allows you to change the sequence in which recipes will appear on the screen.

This screen consists of three buttons:

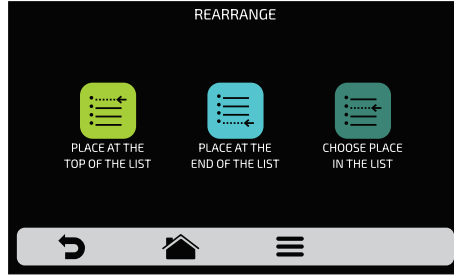



Place at the top of the list: The recipe moves to the top of the group list.



Place at the end of the list: The recipe moves to the end of the group list.



Choose place on the list: The operator will be directed to the recipe screen to choose the position they want.

b) To change the position of a recipe, simply press on the recipe to select and slide  to the desired position. Press  to save the change.

c) If the replacement is made vertically (1-2, 3-4, 5-6, and 7-8) the two recipes in question will change position without changing the order of the other recipes, as shown in the image below:

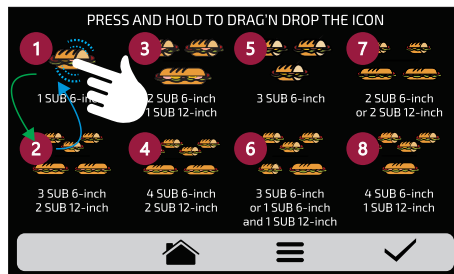

d) If the replacement is done randomly, once the position is selected, the recipes will be sorted sequentially (1, 2, 3, 4, 5, 6, 7, and 8), as shown in the image below:

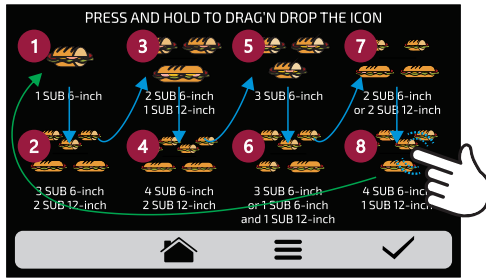

e) Use  to return to recipe editing options.

COOK/BROWN MORE

a) The **cook/brown more** function is defined by recipe, i.e. it is not a fixed value for all recipes so the user can define the time they want for each option.

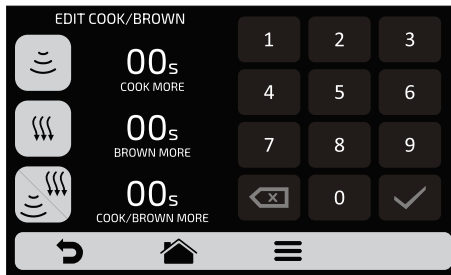

Keep in mind that:

- **Brown more** - only hot air is triggered;
- **Cook more** - only microwave is activated;
- **Cook/brown more** - alternates between heating and browning.

b) To set the time, simply click on the location of the value as shown on the display.

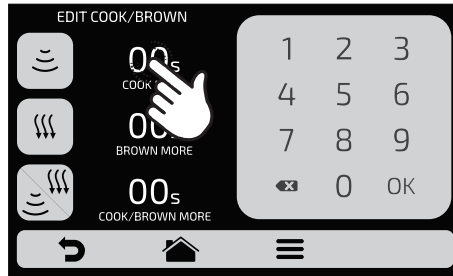

c) Use the keypad to enter the time and click ✓.

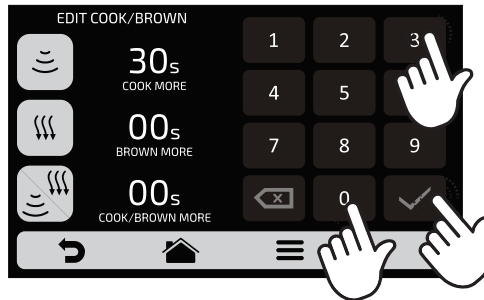

d) The **cook/brown more** feature can be disabled in the **edit access setting** (see page 60).



e) Use ↶ to return to the recipe editing options.

ADD / REMOVE FAVORITES

a) The **favorites** function can be accessed via the options key on the fixed bar, which will be explained in detail on **page 65**.

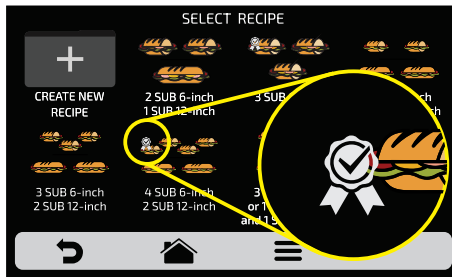
b) To bookmark the recipe, click on the 📌 icon. A small ribbon 🏆 will be added to the top left corner of the recipe icon.



c) To remove the recipe from favorites, repeat the process. On the recipe editing options screen, the remove from favorites icon will appear:  , by clicking on it, the  ribbon will disappear from the icon and the recipe is removed from the favorites list.

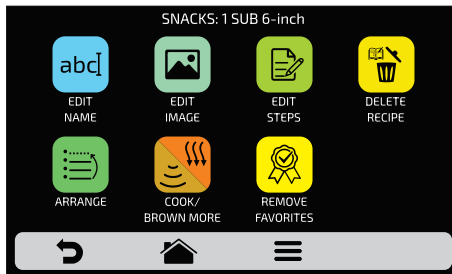



d) Use  to return to user editing options.

USER SETTINGS: PRE-HEAT

a) Editable parameters in pre-heat are:

- **Temperature Preheat 1.**
- **Temperature Preheat 2.**
- **Preheat time:** *the purpose of this function is to set the time to allow for an uniform temperature on the oven chamber after pre-heating, as this time guarantees the good performance of the equipment in the execution of the initial recipes of an operation.*

b) The  /  button enables/disables **Temperature Preheat 2**. When disabled, all settings related to Temperature Pre-heat are hidden.

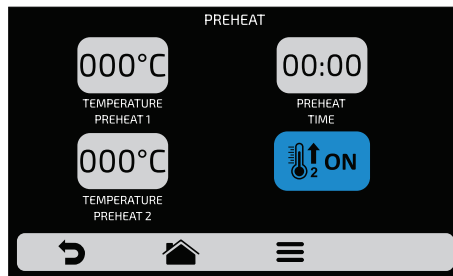

c) To edit the values using the keypad, press the  and  icons.

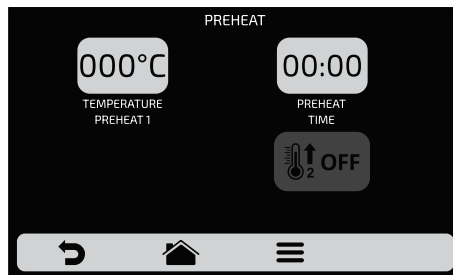

52 d) Use  to return to user editing options.

USER SETTINGS: CURRENT TEMPERATURE

a) The current temperature screen  : is informational only. It allows to check the temperature of the chamber resistance.

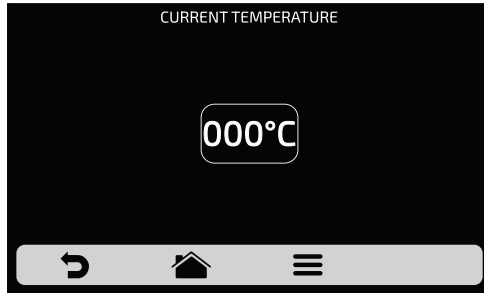

USER SETTINGS: CELSIUS/FAHRENHEIT

a) To change the temperature format between Celsius and Fahrenheit as displayed in the oven, click on the  icon in the user settings, and set the temperature format you want.

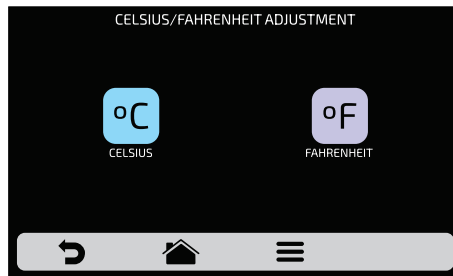

b) Use  to return to user editing options.

USER SETTINGS: USB

a) Press the  button. The functions available on USB are: import and export.



b) When selecting one of the functions, the message: “**Insert the USB stick and wait for recognition**” will appear.

c) After recognition, the user will be redirected to the options of the function they chose earlier:

Import: Import all, import groups, or import settings.

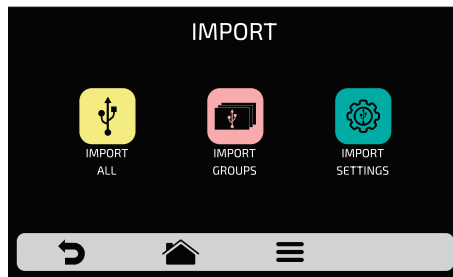

- **Import All:** Transfers all groups, recipes, and user settings from the USB stick to the equipment.
- **Import groups:** Transfers all groups and recipes from the USB stick to the equipment.
- **Import settings:** Transfers the settings from the USB stick to the oven.

Imported settings functions: date and time, recipe check, heating and browning status, auto import, favorites, manual mode, operator mode, repeat recipe, date format, time format, hour format (AM/PM), language, preheat 1, pre-heat 2, enable pre-heating, sound, pre-heating time and temperature unit.

Note: When importing **groups, recipes or settings** from a USB stick to the equipment, all information in the oven will be deleted and replaced with the imported information.

Export: Export all, export groups, or export settings.

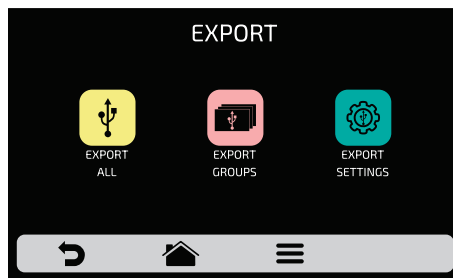

Export All: Transfers all groups, recipes, and user settings from the oven to the USB stick.

Export groups: Transfers groups and recipes from the oven to the USB stick.

Export settings: Transfers the settings from the oven to the USB stick.

Functions with exported configuration: date and time, recipe check, heating and browning status, auto import, favorites, manual mode, operator mode, retry recipe, date format, time format, time period (AM/PM), language, preheat 1, preheat 2, enable preheat, sound, preheat time, and temperature unit.

Note: When importing **groups, recipes or settings** from the oven to the USB stick, all information in the USB stick will be deleted and replaced with the imported information.

d) If an error occurs, the message displayed will be: "There was an error during import/export, please remove the USB stick and restart the process".

e) Use  to return to user editing options

ACCESS TO THE USB PORT



USER SETTINGS: CUSTOMER SUPPORT

a) On the **Customer Support** screen  , you will find a QR CODE with all contact information. Using the camera on your mobile, scan the QR CODE to access the information.

The Customer Support screen is the only screen that has horizontal scrolling, swipe you finger  to view the QR CODE for all regions.

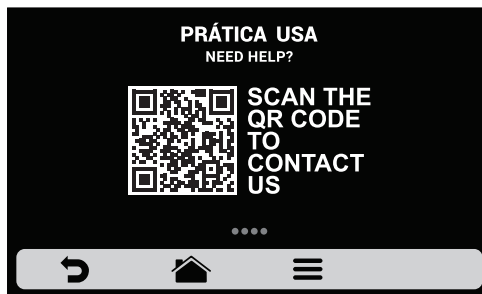

56 b) Use  to return to user editing options.

USER SETTINGS: EXPORT MENU

a) The **Export Menu** function is a shortcut for direct export to the USB drive.

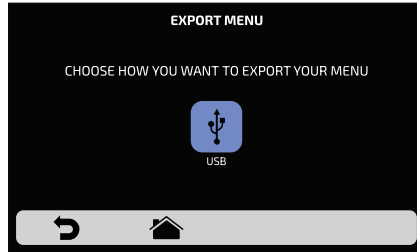

• **USB:** exports the menu directly to the USB stick.

b) Use  to return to the user settings options.



USER SETTINGS: SYSTEM

a) The  **system** screen consists of the following items. Understand fully each item on the following pages.



b) Use  to return to user editing options.

SYSTEM: LANGUAGES

a) To change the language , simply click on the icon to choose the desired language. Swipe your finger  over the screen to view all languages available.

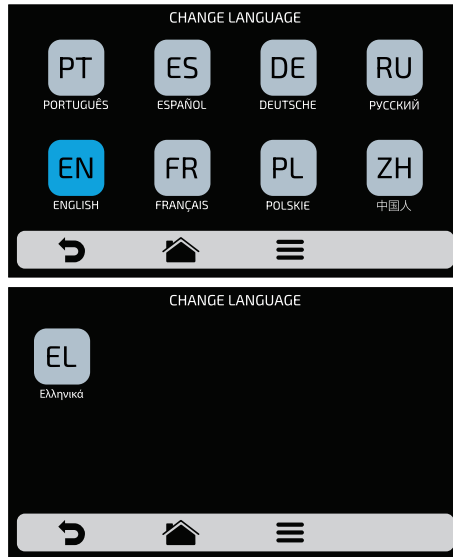

b) Use  to return to the user settings options.

SYSTEM: DATE/TIME

a) It is possible to adjust the date, time and format  that should be presented to the user, according the following standards:

EUROPE: DD/MM/YYYY **HOOR:** 24H FORMATTING
EUA: MM/DD/YYYY 12H FORMATTING
ISO: YYYY/MM/DD

b) Access the DATE/TIME screen to configure the formats and the time zone. Choose the format in which the date will be displayed.

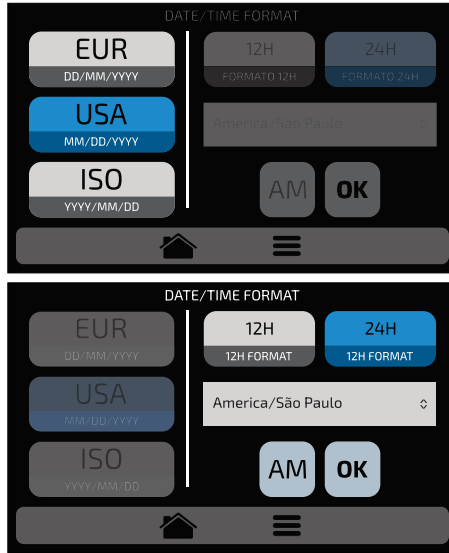

c) Then, select the TIME_ZONE from the available list. The time will be adjusted automatically according to the selected time zone.



d) After completing the settings, press OK to confirm.

e) Use TEC to return to the user settings options.

SYSTEM: CHANGE PASSWORD

a) You can change the user password  by simply entering the new password and then confirm it by clicking .

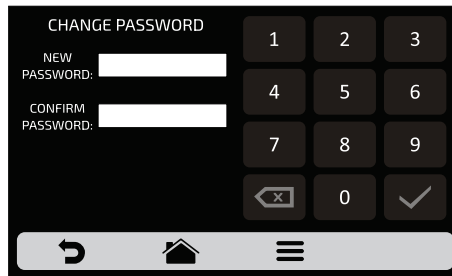



b) Please contact the technical support if you forget your password (see page 82).

c) Use  to return to the user settings options.

SYSTEM: RESTORE ORIGINAL SETTINGS

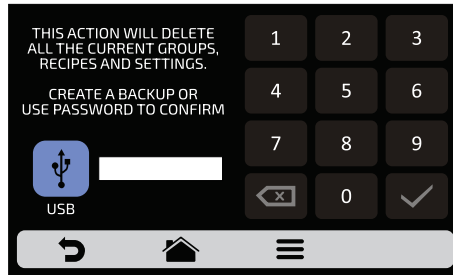
a) **ATTENTION:** The factory reset  option will delete all groups and recipes, in addition to user-defined settings. Make sure to backup your information in a USB stick before proceeding. **After you enter the password and launch: YOU WILL NOT BE ABLE TO RETRIEVE YOUR INFORMATION.**



b) Use  to return to the user settings options.

SYSTEM: EDIT ACCESS

a) **Edit access**  corresponds to the function that blocks any functions operators have access to.

For example, if you want favorite functions and manual mode to be never accessed by operators, simply click on both, which will turn dark gray to indicate they are locked until you unlock them.

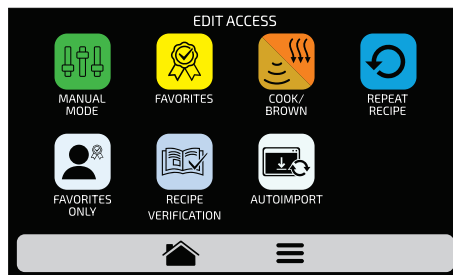

60 b) To unlock, simply click on the desired functions again.

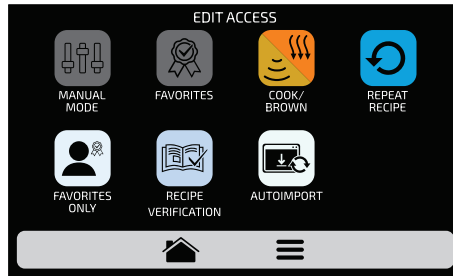

c) The **Favorites Only**, **Recipe Verification**, and **Auto Import** functions only appear on the **Edit Access** screen. The details of these functions are as follows:





Favorites Only: When you enable this function, only favorite recipes will be displayed on the initial recipe execution screen, allowing the execution to be performed with just one click.

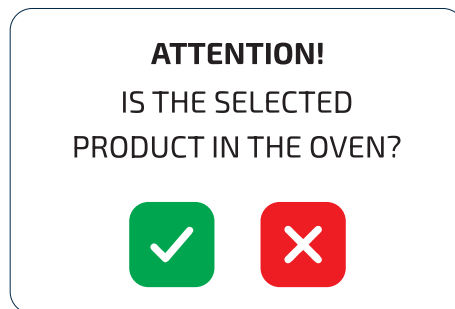

Recipe Verification: When you enable this function, a message will appear to ask if there is food in the equipment, which will always be displayed before starting a recipe.



Confirm by pressing  and the recipe execution will proceed as normal. Pressing  will stop the recipe.



Auto Import: Enabling this function every time the device is turned on will automatically import recipes from a USB stick.

Note: A message will appear asking for the USB stick to be inserted.

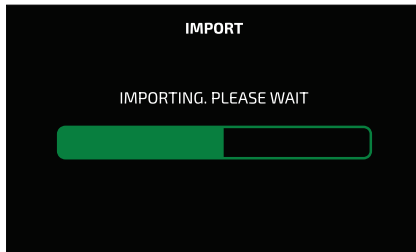

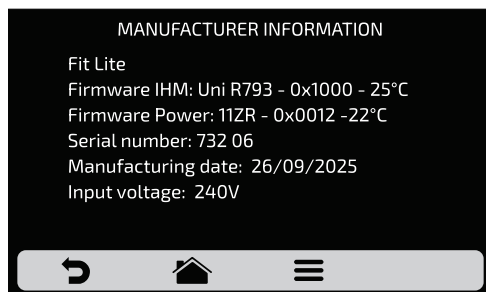

SYSTEM: INFORMATION FROM THE MANUFACTURER

a)  has information on **FIT Lite** firmware version, series and date of manufacture.



SYSTEM: SYSTEM UPDATE

a) Press the  key and choose the option: 

Note: The  option should only be used by an authorized technician.

b) Select the USB option.

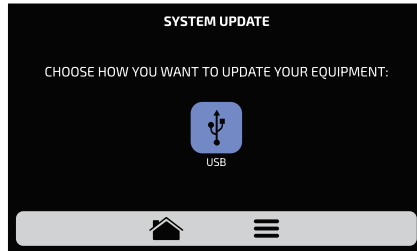

c) After selecting the USB option, the oven will start the update automatically.

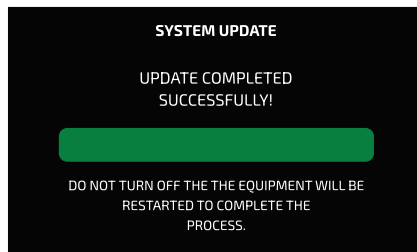

d) At the end of the process, will restart automatically. Please wait.

e) If an error occurs, the following message will be displayed on the screen: **"An error occurred during the system update. Would you like to restart the process?"**

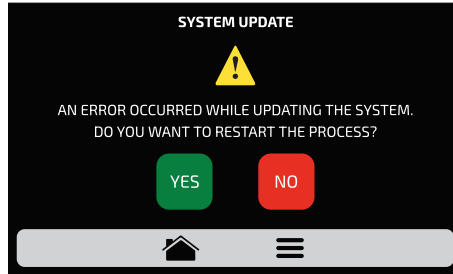



YES Restarts the update process.

NO Sends you back to the settings menu.

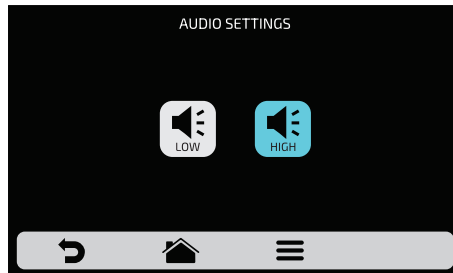

SYSTEM: VOLUME

a) On the volume screen , you can adjust the sound.



64 b) Use  to return to the user settings options.

FAVORITES

a) The Favorites functionality acts as a shortcut. This function allows easy access to your most used recipes. To access this function, simply press the  option button on the fixed menu bar and then press the  button.

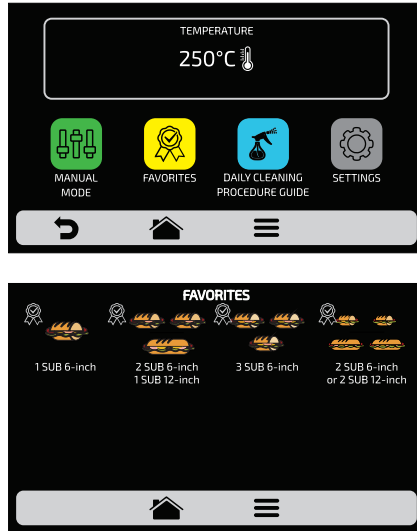

b) Swipe your finger  over the screen to view all available recipes

c) See how to add or remove a recipe from the favorites list on **page 50**.

SOUND ALARMS



- At the end of a recipe, the alarm will sound to indicate the end of operation.





- If the oven door is left open for more than 30 seconds, the alarm will sound to alert the user.



- **Caution:** If the audible alarm sounds continuously, the equipment is not functioning properly. Turn the equipment off or disconnect the power cord and read the instruction manual before operating.

MANUAL MODE

a) The **Manual mode** can be used to test new recipes or run recipes quickly. It is possible to define and execute a recipe's step and if your test result is a pass, it is possible to turn it into a recipe at the end of the operation.

b) To access the manual mode, click the  radio button. On the options screen, press the  icon.

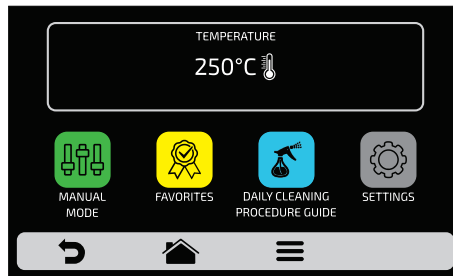

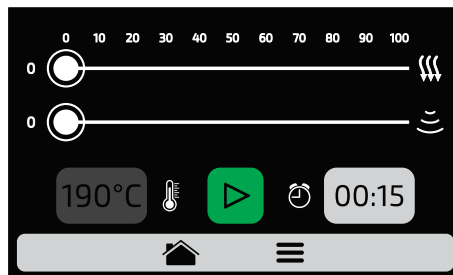

c) Set the parameters for time, temperature, hot air speed and microwave.

d) Press the  button to start operating in the manual mode

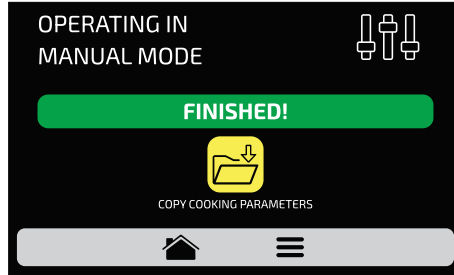

e) Upon completion of the operation, the copy parameters icon will be enabled  .



f) **Copy parameters** allows the user to carry the parameters defined in **manual mode** to the **editing groups and recipes**, i.e. by clicking on the  icon, it will be necessary to enter the user password for access to the settings.

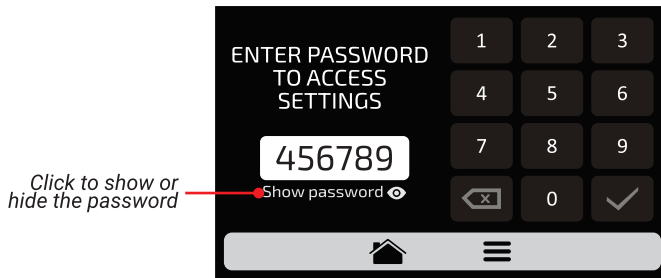

g) After entering the user password, choose between creating a new group or allocating the parameters carried over into a new recipe in an existing group.

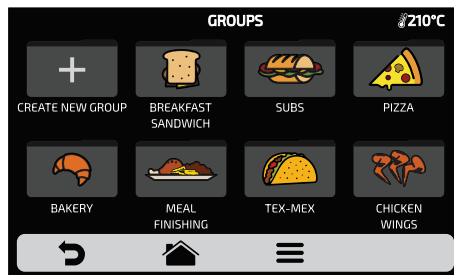

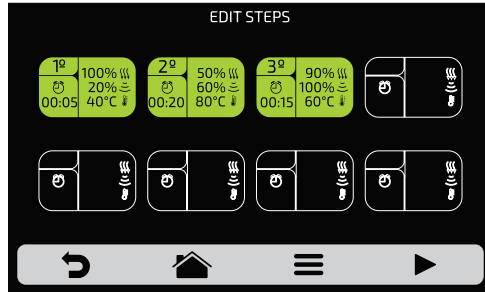

h) Define the name and the image of the new recipe and choose which position (step) you want to allocate the transported information to.



i) To finalize, define the other steps of the recipe, if desired.

DAILY CLEANING GUIDE

a) To assist in cleaning the **Fit Lite**, use the **daily cleaning guide**. It can be accessed in the  **options** screen, then click on the  button. Follow the steps on the screen carefully.

b) To clean your **Fit Lite** oven, we recommend using the *Oven Cleaner* (degreaser) and the **Oven Protector** (antifat) from **Prática**.



c) By pressing the  button on the screen, you can watch a video at each step of the cleaning.

1°: Open the oven door and allow the oven to cool down to the temperature indicated on the panel. Click the arrow to proceed: 



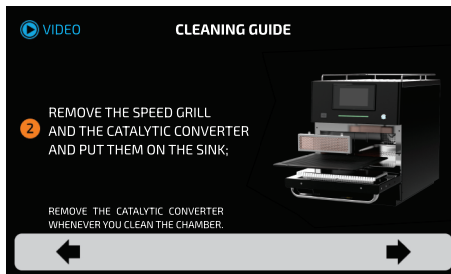

2°: Remove the speed grill and the catalytic converter and put them on the sink. Click the arrow to proceed: 



Note: Immediately after completing step 2, the following message will appear on the screen:



If you click on , a screen for cleaning the catalytic converter will be added to step 3; if you click on , the cleaning will go on without the additional step.

Caution: After cooling the oven and before applying the fat remover, wipe the surfaces of the chamber with a damp cloth to decrease the temperature.

3°: 1/2 - Apply Oven Cleaner on the speed grill and let it soak while you perform the next steps. Click the arrow to proceed: 

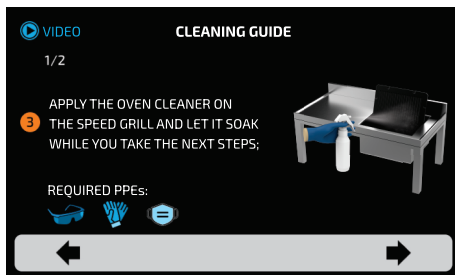

3°: 2/2 - Soak the catalytic converter in a water and soap solution when performing the regular cleaning. Click the arrow to proceed: 



4°: Apply the Oven Cleaner to the chamber walls and in the inside of the door and let it soak for 5 minutes.

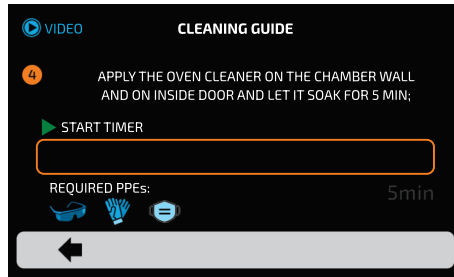

STEP COMPLETE. GO ON!

The alarm will sound and the next screen will be released after 5 minutes.
Click on  to proceed

5°: Use a non-abrasive sponge to clean the whole chamber and ceiling. Click the arrow to proceed: 

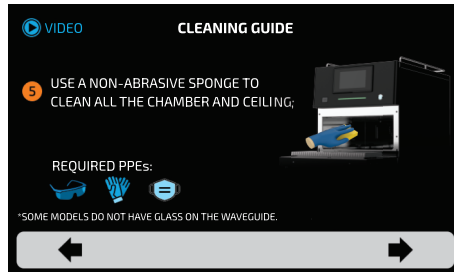

6°: Clean the chamber with a wet cloth to remove excess, then wipe it with a dry towel. Click the arrow to proceed: 

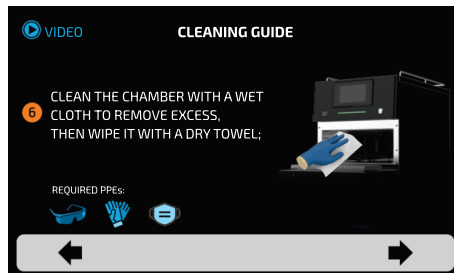

7°-1/2: Apply vinegar through the whole oven's chamber and the door and spread it evenly. Click the arrow to proceed: ➡

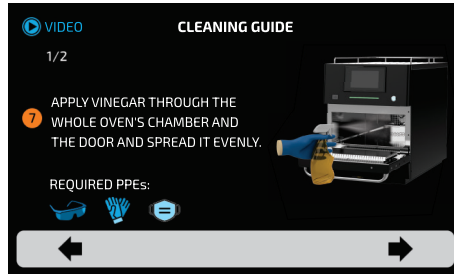

7°-2/2: Clean the chamber with a wet cloth to remove any vinegar excess, then wipe it with a dry towel. Click the arrow to proceed: ➡

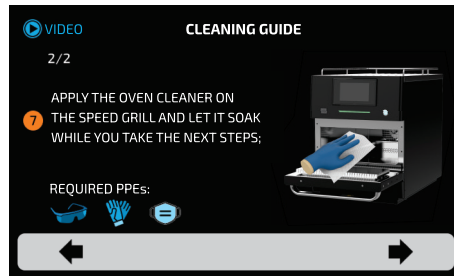

8°: Apply Oven Protector through the whole oven's chamber and the door and spread evenly with a paper towel. There is no need to rinse. Click the arrow to proceed: ➡



9°-1/2: Use a non-abrasive sponge to remove the most adherent stains from the Speed Grill. Click the arrow to proceed: ➡

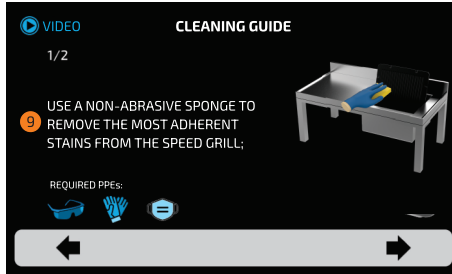

9°-2/2: Rinse the Speed Grill and the catalytic converter if both were cleaned. Click the arrow to proceed: ➡

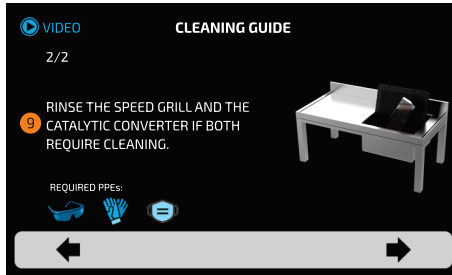

10°: Fit the catalytic converter and the Speed Grill properly. Click the arrow to proceed: ➡



11°- 1/3: Remove the air filter in the front of the oven and let it soak in a container with water and detergent. Click the arrow to proceed: ➡

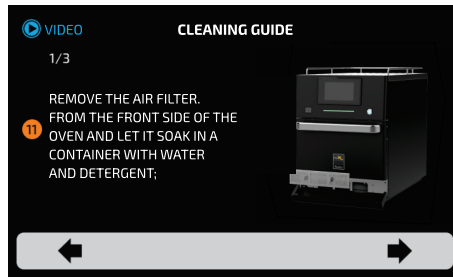

11°- 2/3: Remove the stickiest dirt with running water and clean with a non-abrasive sponge with detergent. Click the arrow to proceed: ➡



11°- 3/3: Rinse the filter with running water, dry it and fit it onto the oven. Finishe the cleaning by clicking the arrow: ➡

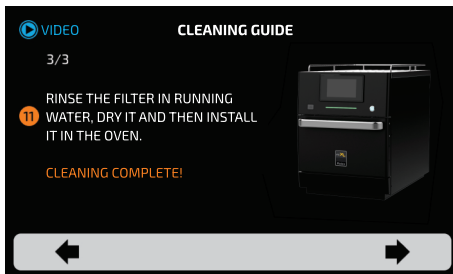

CATALYTIC CONVERTER CLEANING GUIDE

a) Remove the catalytic converter by vertically moving upwards and then pull it back as shown in the image:

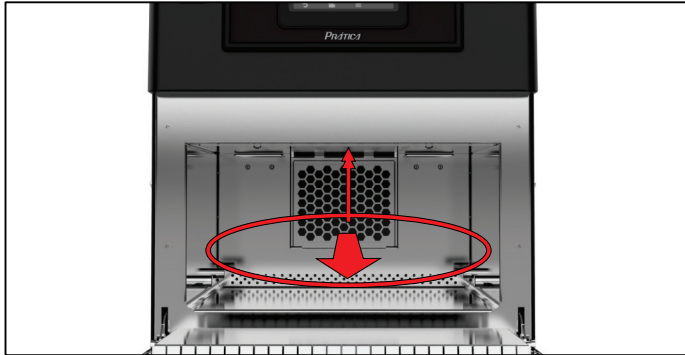

b) If the catalytic filter has gone a long time without the required cleaning, the following message will be displayed on the screen:

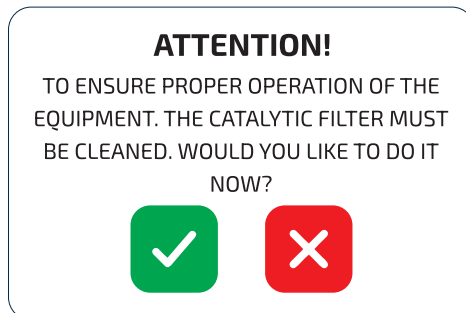

Attention: If the message is canceled  , it will be displayed every 1 hour until the filter is cleaned and the message is confirmed  .

If confirmed, the following CLEANING screens will be displayed:

1°: Open the oven door and allow the oven to cool down to the temperature indicated on the panel. Click the arrow to proceed: ➡

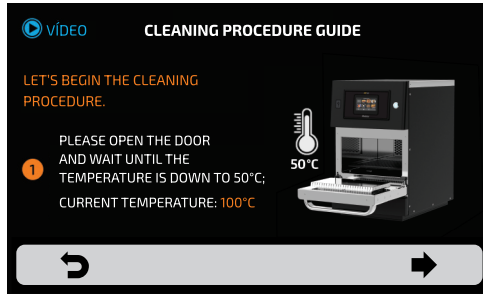

2°: Remove the rack, the back of the oven chamber and the catalytic converter and place them on the sink. Click the arrow to proceed: ➡

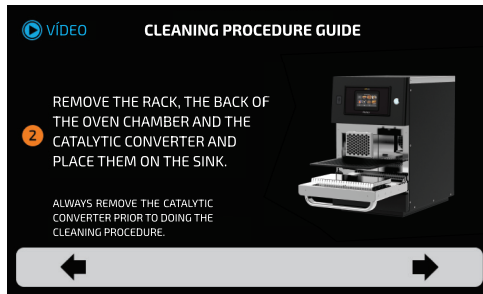

3°: To wash the catalytic converter place it in a container with water and soap and **let it soak**. Click the arrow to proceed: ➡

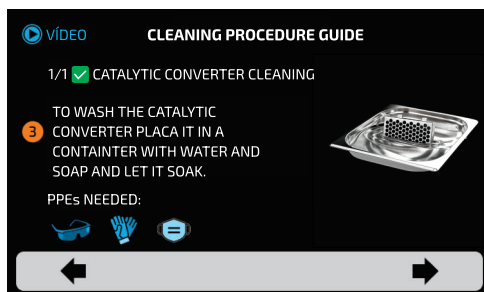

4°: Rinse the rack, and the catalytic converter after applying cleaner or after soaking it in soap water. Click the arrow to proceed: ➡

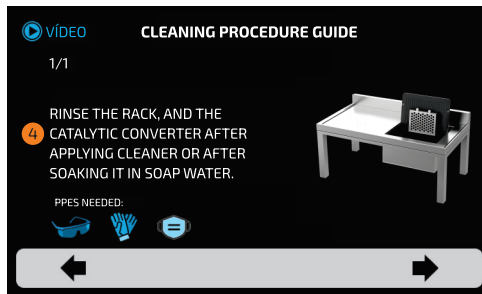

5°: Put back the catalytic converter, the back of the oven chamber and the rack. Make sure it fits correctly. Finish the CLEANING process by clicking the arrow: ➡



c) After CLEANING, the EQUIPMENT will perform a 10-second countdown and will restart automatically, completing the CLEANING process.

AIR FILTER CLEANING GUIDE

- a) To access the air filter, open the oven front rail.
- b) Next, remove the filter by pushing it backwards using the filter tabs as shown below:

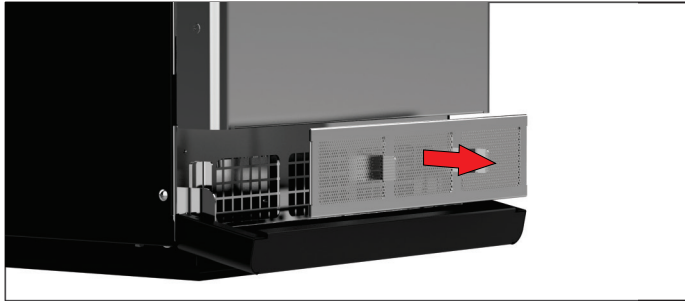

Note: The air filter should be cleaned Every two days.

IMPORTANT: If the air filter has gone a long time without the required cleaning, the following message will be displayed on the screen:

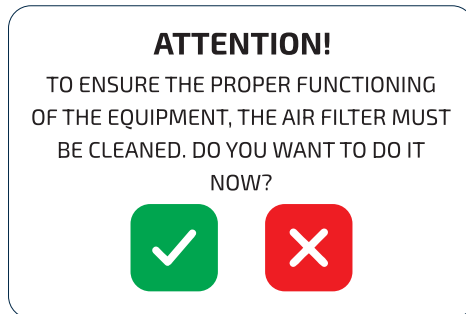

Attention: If the message is canceled  , it will be displayed every hour until the filter is cleared and the message is confirmed  .

c) If confirmed, the following CLEANING screens will be displayed:

1°- 1/3: Remove the air filter located at the front of the oven. Click the arrow to proceed: ➡

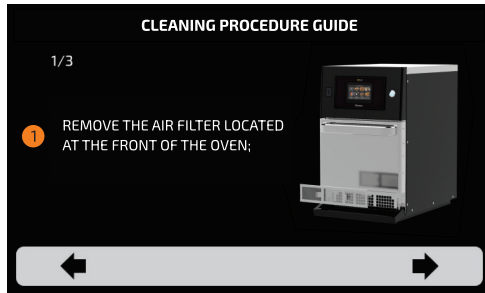

1°- 2/3: Remove the most adhered dirt under running water and use a non-abrasive sponge with detergent to clean; Click the arrow to proceed: ➡

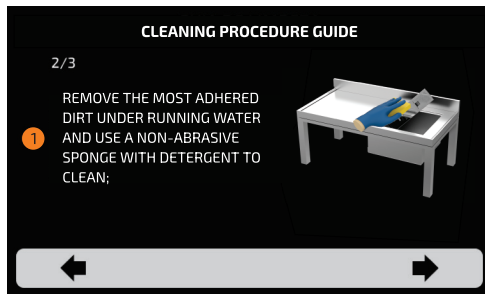



1°- 3/3: Rinse the filter under running water, dry it and install it in the oven. Finish the CLEANING process by clicking the arrow: ➡



d) After CLEANING, the EQUIPMENT will perform a 10-second countdown and will restart automatically, completing the CLEANING process.

ALERTS AND ERRORS: POSSIBLE SOLUTIONS

- a) The **Fit Lite** is programmed to warn of any possible errors and alerts that may occur during operation.
- b) A flag will appear over the  options icon; it will be yellow for alerts () and red for errors ().
- c) See how to proceed in each case below:

ALERTS

- a) Click the  options icon

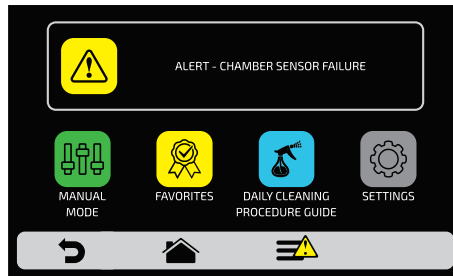

- b) The **options** screen will bring a description of the alert instead of the chamber temperature:

WARNING - CHAMBER SENSOR FAILURE

- c) Follow the instruction as described on the screen. In this case, switch the oven off and on again using the panel button:



Note: If you press the **on/off** button the following message will be shown on the screen:

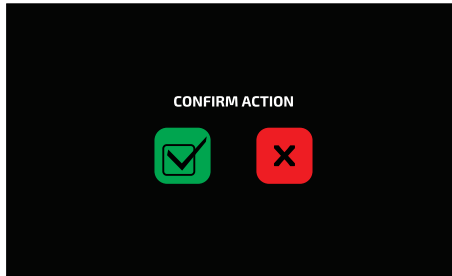

Note: It is also possible to press the **on/off** button for 3 seconds to shut down the equipment directly.

d) After turning up the equipment, if the error persists, call Prática Technical Support (*see page 82*).

 **ERRORS**

a) In case of multiple unsuccessful attempts to reset, the alert will become an error and you will need to contact Technical Support (*see page 82*).



b) See the following table for possible errors and alerts.

TABLE OF ALERTS AND ERRORS

Component	It becomes an alert when	It becomes an error when	Sound alarm of error
Inverter	No communication	-	Off
Inverter	-	More than 10 reboot attempts	On
CAN network communication	-	Cables disconnected or defective	On
	-	Sensor inactive	On
Temperature on the panel	65°C / 149°F to 80°C / 176°F	Above 80°C / 176°F for 10 minutes	On

You may call us to provide feedback, offer suggestions, or receive technical support:

Phone: +55 (35) 3449-1235

Email: comex@praticabr.com

Marketed globally by:

TRUFROST AND BUTLER PRIVATE LIMITED

1215, 12th Floor, Tower B, Emaar Digital Greens, Golf Course Extn. Road,

Sector 61, Gurugram – 122011

T. +91-7303166766 info@trufrost.com

www.trufrost.com