



USER MANUAL

**Electric Convection Oven:
Prodigy - Convex**



Electric Convection Oven

Prodigy - Convex

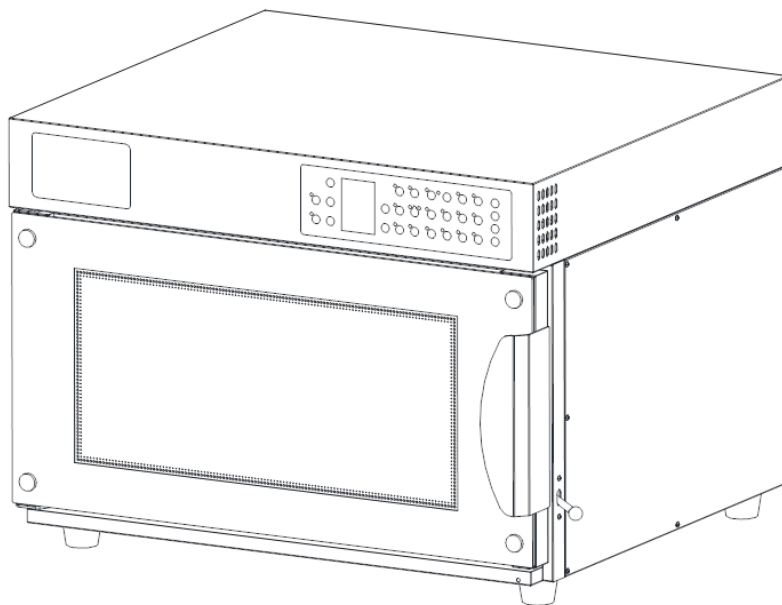

Thanks for your using of our company product, in order to ensure the product performance give full play to the role, please have a read of this manual to reduce unnecessary loss and damage, and get a further study of our product characteristic、 installation and operation. Also please keep the manual for further reference.

Index

- I. Safety
- II. Operating of the digital board
- III. Functions
- IV. Machine illustration diagram
- V. Installation instruction
- VI. Warning
- VII. Maintenance
- VIII. Trouble shooting
- IX. Specification
- X. Wiring diagrams



Safety

1. Make sure the input power is suitable for this oven using. The parameter of the socket and the plug should be match.
2. The oven should be working inside the temperature range which is mentioned on the parameter, and the ground wire must be connected.
3. The oven shouldn't place near oil drum/cotton/cloth and any other inflammable materials. Also please don't washing or spraying beside the oven.
4. Please prevent any object from drop into the oven to make it short out.
5. Please don't leave the oven while it is working.
6. Please don't clean the oven while it is working, and don't wash it with gasoline.
7. Don't use damaged power wire, and replace the damaged spare part before using in case of electric leakage.
8. Please turn off the power before maintenance.
9. Sharing the same ground electrode with any other machine is forbidden.
10. The oven should be installed or maintained by professional serviceman.
11. Please leave enough space behind the oven for heat dissipation.

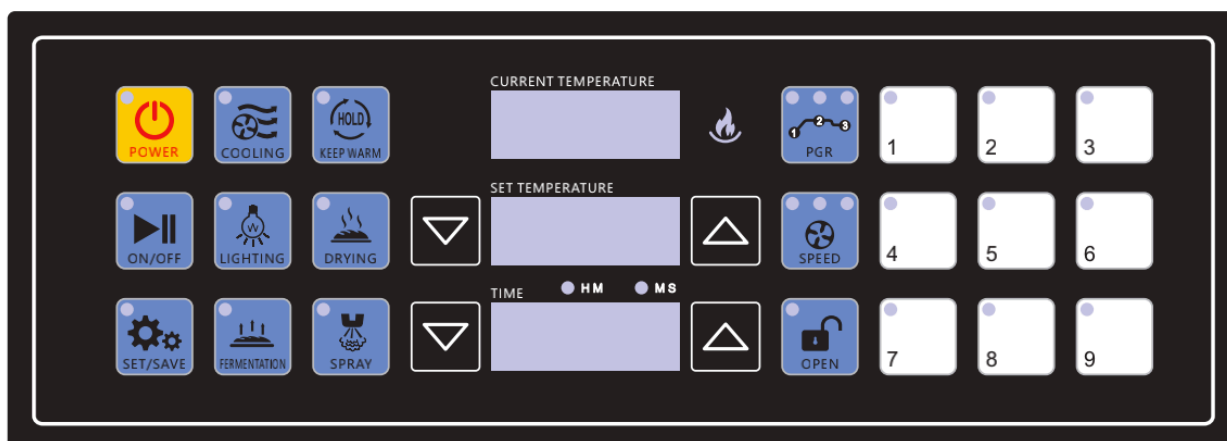



Operating of the digital board



Power switch: long press 2s to turn on or turn off the power; short press once to reset (when you need to use other function, you can short press the power button, then choose the function you need).

On/off switch: convection heating is the default option, press   to adjust the temperature (long press the up or down button for 3s and the number can skip), then press on/off button to start heating. The timer would not count down during preheating period. And it would alarm when the oven reach its set temperature, then the time window display "Food" and the oven enter heat preservation status (if there are no operation in 15min, the oven would stop heat preservation and turn off). Now you can open the door and put in your food, the oven would start working after you close the door, and the timer start counting down. You can press "on/off" button to stop anytime, also you can press it to restart the remain working period.

Programming: you can preset 3 different programs at most.

For example, turn on the power and press number "1", the current temperature window display "P001", now you can use the   button beside the set temperature window to adjust the temperature, and use the   button beside the time window to adjust the timer, then press "set" button twice to confirm, and the buzzer alarms four times which means you have finished the program 1 setting, next time when you turn on the power and press number "1", then press "on/off", the oven would start working under program 1.

Steam on/off: you can set the steam temperature after pressing the "steam on/off" to cook food by steaming.

Caution: when you cook food with steaming function, the spray function and convection heating function should not be used at the same time.

Current temperature display: after the oven start working, the actual temperature inside the chamber would display on the window. When you open the door and put in your food, the temperature would change alongside.

Set temperature display: it only display your set temperature or the default temperature of the function.

Time display: to display the timer counting, and it wouldn't count during preheating period.

Lighting: press once, light on; press again, light off.

Spray: when the current temperature reach 120°C, you can press “spray” button to spray the food.

Speed: There are three different speed mode (fast、normal、low) you can choose.

Open: You can press OPEN button to open the door when the power is on, if the power is off, you can use the door handle at the right side of the oven to open.

Function

1. Circulation heating, and the temperature is in the form of convection motion when cooking, which make the food get heated more evenly.
2. Can cook food by steaming, and the maximum temperature of steam is 150°C.
3. 99 minutes timer.
4. 350°C thermostat.
5. Spray function is applicable.
6. Cooling function is applicable.

Machine illustration diagram

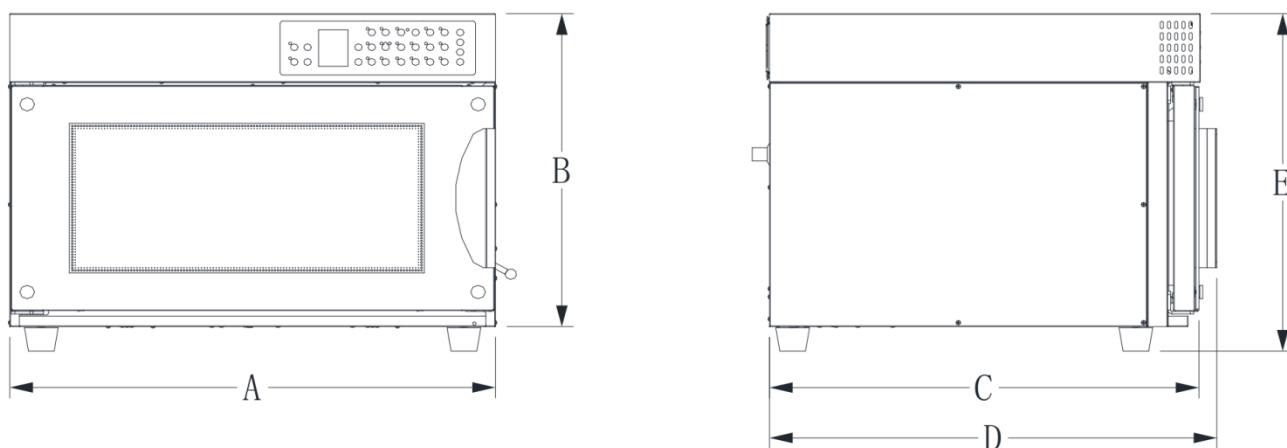

Model	A(mm)	B(mm)	C(mm)	D(mm)	E(mm)
Prodigy - Convex	960	740	835	890	785

Installation instruction

1. All the electrical power unit and circuit connection must be installed by qualified electrician with safety standard.
2. Connection must be based on requirement.
3. Make sure the rubber feet have been installed securely.
4. Product should be placed in a well ventilated room on solid platform, and we suggest to leave at least 10cm space between the product and the wall or barriers. Also place the product away from the combustible materials and equipped with fire extinguisher.
5. Remove the packaging film off the surface.
6. The power wire should be connected in accordance with electrical safety standards. Make sure the voltage and frequency conform to the parameter. And please install a double pole switch before connection. When the product working, the voltage error should be under $\pm 10\%$ (**PS: the product must be connected to ground.**)
7. Connect the cable to the power supply fixed by using a screwdriver according to the connection diagram, then loosen the screw inside the power point and plug the cable in, make sure the sheet copper compress the power line tightly. If the connection is incorrect, it may cause joint heating and burning off the power cord.
8. Connect the water inlet behind the case to the water pipe with the configured bellows, and add a strainer on the water pipe joint in case of magnetic value block. Also there is an exhaust pipe behind the case for needless steam to exhaust.

Warning

1. If you want to clean、repair or move the machine, please pull out the plug first.
2. Please don't touch the switch or plug with wet hand.
3. The machine can't be flushed directly, and please be careful don't let the water flow into the switch when cleaning.
4. Keep the children from touching or using the machine.
5. The ground wire must be connected, all the connection must be reinstated after maintenance.

Maintenance

1. Please pull out the plug first before maintenance, and clean it after cooling down the machine.
2. For daily cleaning, you can use a dry cloth to wipe off the grease on the chamber, don't flush the chamber directly. For the baking stone cleaning, please take out the stone, use a fur blush to clean its surface, and rinse it with water and dry it. (Don't use any cleanser essence to clean the baking stone, because the stone can strongly absorb water, so that the cleanser would be absorbed at the same time, it may affect the flavor of the food.)
3. We suggest maintain the machine by qualified electrician once in a month.

4. User need to know
 - 4.1. When doing maintenance please first pull out the plug.
 - 4.2. Before cleaning, please first cool down the chamber, and please don't use acid cleanser for cleaning.
 - 4.3. Only qualified staff can use the machine.
 - 4.4. Operator should read this manual to learn the function and operating of the oven before using.
 - 4.5. Please keep this manual for further reference.
 - 4.6. This machine can be only used for roasting and baking food, and it isn't applicable for any other using. And the thermostat can adjust the temperature between 20~350°C.
5. The oven is applicable for baking fresh or freeze flour products or meat.
6. Each baking plate should have 4cm space between during cooking, and please don't place too much food on it to keep the hot air circulating.

Trouble shooting

Stoppage	Solution
Not heating up	<ol style="list-style-type: none"> 1. Please check whether the connection is loose. 2. Set your needed temperature again. 3. Please check whether the power switch match up with the parameters 4. Contact the service center for repair suggestion.
Short circuit	Contact the service center for repair suggestion
Internal light not work	<ol style="list-style-type: none"> 1. Please check whether the connection is loose. 2. If the bulb is broken, pull out the power plug, cool down the chamber, then replace a new bulb.
Scorching smell appear	Contact the service center to check whether the connection short out.
Baking unevenly	Readjust the thermostats for each heating elements to see how they work, if they don't work well, please contact the service center to check whether the heating element need to change.
No steaming	<ol style="list-style-type: none"> 1. Please check whether the water pipe joint is blocked or disconnected. 2. Please check the water faucet is blocked or disconnected. 3. Please check if the magnetic valve works well, if it doesn't, please replace it with a new one.

Specification

Model	Temperature range	Dimension (mm)	Internal dimension (mm)	Voltage(V)	Power (KW)
Prodigy - Convex	5~350 °C	960X890X740	753X529X480	220V	6

Wiring diagrams

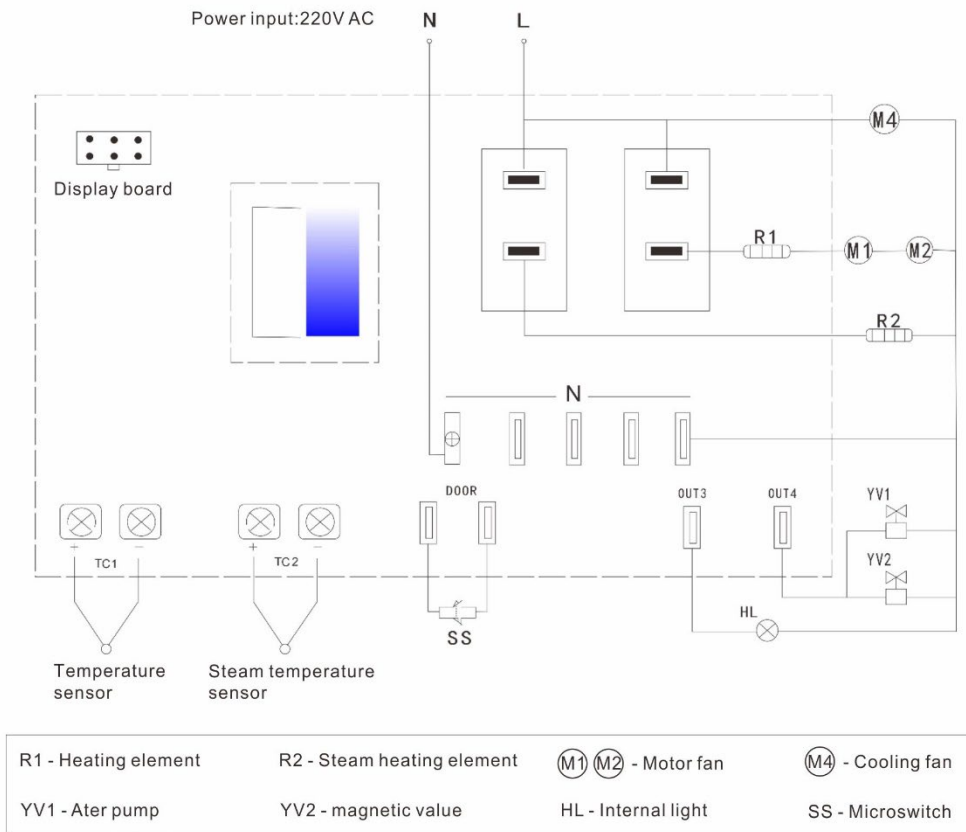

Marketed globally by:

TRUFROST COOLING PRIVATE LIMITED

1215, 12th Floor, Tower B, Emaar Digital Greens, Golf Course Extn. Road,

Sector 61, Gurugram – 122011 (India)

T. +91-7303166766 info@trufrost.com

www.trufrost.com