

TRUFROST & BUTLER

USER MANUAL

Gelato Showcase

Wow Gelato 12

1. NOTES/WARNINGS	3
2. WARRANTY TERMS AND CONDITIONS	6
3. EQUIPMENT IDENTIFICATION	6
4. USE	6
4.1 COMPOSITION	7
5. SAFETY	7
5.1 SAFETY DEVICES PRESENT	7
5.2 FIXED PROTECTIONS	7
5.3 ISOLATING THE ELECTRIC POWER SUPPLY	7
5.4 RESIDUAL RISKS	8
5.5 RISKS OF CONTACT WITH LIVE PARTS	8
5.6 FIRE	8
5.7 EXPLOSIVE ATMOSPHERE	8
5.8 SLIPPING	9
5.9 TRIPPING	9
5.10 CIRCUIT FAULTS	9
5.11 WARNING SIGNS(IF ANY)	9
5.12 FALLING OBJECTS	9
5.13 COOLING	9
5.14 FOODSTUFFS SAFETY(PACKAGED PRODUCTS)	9
6. DISPOSAL OF WASTE MATERIAL	9
7. INSTALLATION	10
7.1 STORAGE AND UNPAKING	10
7.2. ENVIRONMENTAL CONDITIONS	11
7.3. INSTALLTION	11
7.4. ELECTRIC CONNECTION	11
7.5. POSITIONING/LEVELLING	12
8. MAINTENANCE	12
9. FAULTS-TECHNICAL AFTER-SALES ASSISTANCE	13
9.1. ALARMS LIST	14
10. TECHNICAL SPECIFICATIONS	14
10.1. GLASS	15
11. CONTROL PANEL	15
11.1. USER INTERFACE	15
12. CLEANING	17
12.1. INTERNAL	17
12.2. CLEAN CONDENSER FILTER	18
12.3. SLIDING CLOSURE	18
13. WIRING DIAGRAM	19

1.NOTES/ WARNINGS



NOTE

The content of this manual is of technical nature and is owned by manufacturer. It is forbidden to reproduce, circulate or modify all or part of its content without written consent. Any infringement will be legally pursued.

The manual and the conformity certificate are an integral part of the equipment and should always accompany the product in the event of a transfer to a new location or to a new owner. The user is responsible for the integrity of these documents, for their consultation and during the whole life cycle of the equipment itself. Keep this manual in a safe place. It should be available for consultation near the equipment at all times. If lost or destroyed you can request a copy of the manual from manufacturer by specifying the exact model serial number and year of manufacture. The manual reflects the manufacturing technology at the time of supply. The manufacturer reserves the right to modify its products in any way it deems necessary, with no obligation to update manuals and machines relating to previous manufacturing batches.

As long as supervised or after having received training regarding safe use of the equipment and have an understanding of the inherent risks involved. Do not allow children to play with the device. The cleaning and maintenance that the user will carry out must not be undertaken by children without supervision.

Always refer to this manual before going ahead with any operation. Before doing any type of work, disconnect the equipment from the power supply. Any work on electric and electronic parts or cooling system components should only be carried out by trained personnel in compliance with current laws.

The Manufacturer cannot be held liable for any damage to persons, animals or to the product in the cases below:

- Improper use of the equipment or use of the appliance by unqualified or unauthorised personnel.
- Failure to comply with current legislation.
- Incorrect installation and/or power supply faults.
- Failure to observe the instructions contained in this manual.
- Failure to follow the maintenance programme.
- Unauthorised modifications.
- Installation of non-original spare parts in the equipment.
- Installation and use of the equipment for purposes other than those for which the appliance was designed and sold;
- Tampering with or damage to the power supply cable.

Liability for applying the safety instructions contained in this manual is held by the technical personnel responsible for the intended use of the equipment, who should ensure that authorised personnel:

- Are qualified to carry out the requested activity;
- Is aware of and carefully complies with the instructions contained in this document
- Are aware of, and apply, the general safety standards applicable to the equipment.

1.NOTES / WARNINGS

The buyer is responsible for training personnel using the appliance on the risks, safety devices and general health and safety rules required by the laws of the country where the appliance is installed. Users/operators should be aware of the position of all the controls and how they work, as well as of the features of the appliance.

They should also read this manual in its entirety. Maintenance work should be conducted by qualified personnel after the appliance has been prepared adequately..



DANGER

Unauthorised tampering or replacement of one or more parts of the appliance, use of accessories that modify the use of the same and use of spare parts different to those recommended, can become the cause of injury.



DANGER

Any work conducted on the on the appliance **must** involve disconnection from the power socket and in any case, none of the protective elements (grid, casing) should be removed by non-qualified staff. The appliance should not be operated when these protective elements have been removed.



NOTE

In order not to compromise functionality and safety of the appliance, the particularly complex installation and maintenance activities are not documented in this manual and are performed by specialised Manufacturer technicians.

Never use electric devices inside this appliance. Do not use mechanical or other means to accelerate the defrosting process, other than recommended by the manufacturer. Keep the air vents in the casing of the appliance or in the structure built into the wall free of obstructions. Do not damage the refrigerant circuit.

RISK OF EXPLOSION

Do not store in the equipment products which contain flammable propellants and explosives.

STAFF TRAINING

The buyer is responsible for ensuring personnel who will use the appliance and maintenance technical staff are instructed and trained adequately. The manufacturer is available for advice, clarifications, etc. so that the operator and technical staff can use the appliance correctly. To ensure the operator's safety, appliance devices should be kept in constant working order. This manual is intended to illustrate the use and maintenance of the appliance. The operator has a responsibility and duty to carefully observe the instructions contained within it.

Failure to comply with safety standards may result in injury to personnel and damage to the equipment components and control unit. The user can contact the dealer to request additional information not contained in this document, or suggest improvements, at any time.



Before the product is delivered to the customer, it is essential that a **trained technical member of staff** checks that the appliance is operating correctly in order to achieve maximum performance.

1.NOTES / WARNINGS

The safety standards reported in this document are intended for trained, authorised personnel responsible for:

- Transport
- Installation
- Operation
- Management
- Maintenance
- Cleaning
- Putting out of order
- Disposal



ATTENTION

Reading this manual, albeit in full, is no substitute for adequate user experience. therefore it should only be considered a useful reminder of the technical features and the main operations to perform.



NOTE

The installers and users must read and understand the instructions contained herein before any operation on the appliance.

R290 - REFRIGERANT (WHERE APPLICABLE)



The refrigerant **R290** is a gas that is compatible with the environment, but **highly flammable**. Pay close attention during transport, installation and that the destruction not to damage the refrigerant pipelines.

IN THE EVENT OF DAMAGE:

Keep flames or sources of ignition away from the appliance. Properly ventilate the premises for a few minutes. Turn the unit off, pull the plug. Inform customer support service. The more refrigerant containing an appliance, the greater must be the environment in which there is the unit. In areas too small, in the event of leakage can form a flammable mixture of air and gas.

The volume of the room where the appliance is installed must be at least 19 m³ for each cooling system present in the room.



ATTENTION

Maintenance must be performed by qualified personnel that has been to work with flammable refrigerants.

1. NOTES / WARNINGS

R600a - REFRIGERANT (WHERE APPLICABLE)



The refrigerant **R600a** is a gas that is compatible with the environment, but **highly flammable**.

Pay close attention during transport, installation and that the destruction not to damage the refrigerant pipelines.

IN THE EVENT OF DAMAGE:

Keep flames or sources of ignition away from the appliance. Properly ventilate the premises for a few minutes. Turn the unit off, pull the plug. Inform customer support service. The more refrigerant containing an appliance, the greater must be the environment in which there is the unit. In areas too small, in the event of leakage can form a flammable mixture of air and gas.

The volume of the room where the appliance is installed must be at least 17 m³ for each cooling system present in the room.



ATTENTION

Maintenance must be performed by qualified personnel that has beento work with flammable refrigerants.

2. WARRANTY TERMS AND CONDITIONS

The seller's warranty on the equipment is valid for **12 (TWELVE) months from the date of delivery**.The warranty includes repairs or replacements of any faulty parts due to manufacturing processes or installation after written communication has been received, stating the appliance serial number and date of installation. Not included in the warranty:

- All defects caused by incorrect use of the appliance.
- All defects caused by incorrect electrical connection.
- All defects caused by normal wear (for instance compressor failure and fluorescent lamp malfunctioning that is not due to manufacturing defects).
- Calls for installation, technical instructions, adjustments and cleaning the condenser.

If the seller's technical staff detect any tampering, unauthorised repairs or inappropriate use of appliance the warranty will be invalidated.

Shipment of components covered by the warranty is freight collect only.

Any damage to the appliance detected at the time of delivery due to transport must be reported on the same shipping note to claim compensation from the carrier.

The seller cannot be held liable in the event of damage to the preserved product due to appliance failure.

3. EQUIPMENT IDENTIFICATION

- Find the label affixed on the machine to read the technical data.
- Check the machine model and the power supply voltage before you perform any operation.
- If you uncover mismatches, contact the manufacturer or the company that supplied the machine immediately.

4. USE

This appliance is exclusively intended to: **DISPLAY AND SELL SPREADABLE GELATO**

The manufacturer is not liable for injury to persons or damage to property or the appliance itself caused by the displaying of products other than those described above.

**THE APPLIANCE IS INTENDED FOR PROFESSIONAL USE****Uses not allowed**

- Food preservation.
- Displaying and/or preserving non-food products (chemicals, pharmaceuticals, etc...).

4.1 COMPOSITION

The appliance is made up from a unique cabinet, onto which all devices necessary to make it a professional and efficient product for its declared use, are installed.

The appliance is made up from:

- Cooling system at Ventilated Refrigeration
- Condensing unit on board
- Electrical system
- Electronic controller
- Insulated monolithic structure in ecological polyurethane
- Operator side closure with sliding
- Height adjustable feet
- LED lighting
- Pivoting movement wheels

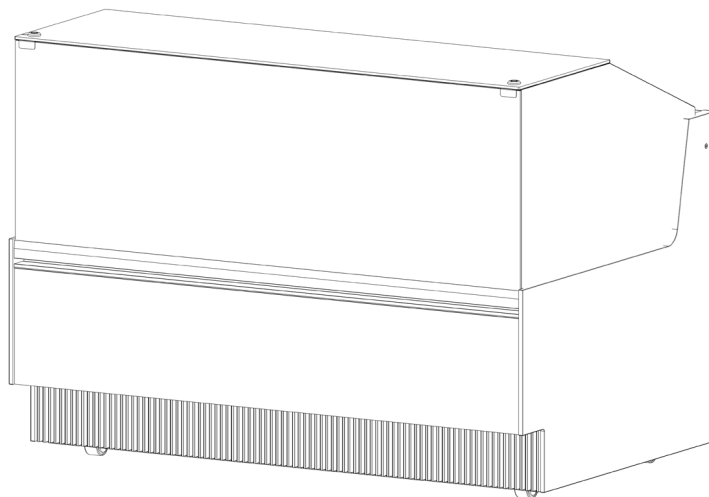

5. SAFETY

The appliance is equipped with safety devices. The buyer is responsible for training personnel using the appliance on the risks, safety devices and general health and safety rules required by the laws of the country where the appliance is installed. Users/operators should be aware of the position of all the controls and how they work, as well as of the features of the appliance. They must also have read this manual in its entirety.

5.1 SAFETY DEVICES PRESENT

Devices whose operation prevents the occurrence of risk situations in operating conditions (e.g. fuses, pressure switches, protections, magnet circuit breakers, etc.).

5.2 FIXED PROTECTIONS

Fixed protective devices consist of fixed perimeter shields, which are used to prevent external parts from entering the equipment.

**DANGER**

It is prohibited to re-start the appliance following maintenance without having correctly restores the panels.

**VISUAL CHECK**

You should check the integrity of fixed panels and corresponding fixings to the frame, focussing in particular on the protective panels.

5.3 ISOLATING THE ELECTRIC POWER SUPPLY

Before conducting any maintenance work on the equipment or part of it, it is necessary to section the power supply that powers it.

**DANGER**

In the event of maintenance operations in which the operator cannot prevent accidental closure of the circuit by others, to totally disconnect the appliance from the mains electricity.

5.4 RESIDUAL RISKS

During design the manufacturer examined all the areas or parts at risk. Therefore, all necessary precautions have been taken to prevent risks to persons and damage to the appliance.

**ATTENTION**

- Periodically check that all safety devices are operating correctly.
- Do not remove the fixed guards.
- Do not introduce objects or tools into the work area.

Although the appliance is fitted with the safety devices prepared, there are still some risks that cannot be eliminated, but reduced via corrective actions by the final integrator and correct operational procedures.

Below is a summary of the remaining risks associated with the appliance during:

- Normal operation.
- Adjustement and tweaking.
- Maintenance.
- Cleaning.

5.5 RISKS OF CONTACT WITH LIVE PARTS

Risk of breaking or damaging the electrical components of the appliance, with a possible reduction in safety levels, following a short circuit.

Before connecting the electricity supply, make sure there is no ongoing maintenance work.

**ATTENTION**

Before making the connection, check that the d.c. current in the installation point does not exceed that indicated on the protections switches present in the electric control board. If this is not the case, the user must envision the relevant limiting devices. It is strictly forbidden to conduct any electrical modification, in order to prevent additional unforeseen hazards and risks.

5.6 FIRE**DANGER**

In the event of a fire, immediately disconnect the master switch from the main power supply line.

5.7 EXPLOSIVE ATMOSPHERE

The equipment must not be located in an area classified as an explosion risk according to 1999/92/EC such as:

Zone 0

An area in which there is a permanent, long-lasting or frequently explosive atmosphere made up of a mixture of air and flammable substances in the form of gases, fumes or steam.

Zone 1

An area in which the formation of an explosive atmosphere, made up of a mixture of air and flammable substances in the form of gases, fumes or steam is occasionally probable during normal activities.

Zone 20

An area in which there is a permanent, long-lasting or frequently explosive atmosphere in the form of clouds of combustible dust in the air.

Zone 21

An area in which the formation of an explosive atmosphere in the form of clouds of combustible dust is occasionally probable during normal activities.

5.8 SLIPPING



DANGER

Any leaks in the areas surrounding the appliance may cause personnel to slip. Check that there are no leaks and keep these areas clean at all times.

5.9 TRIPPING



DANGER

Generally untidy deposits of material may constitute a tripping hazard and a total or partial obstruction of emergency exit routes. You should ensure that operating and transit areas and escape routes are free from obstacles in compliance with current law.

5.10 CIRCUIT FAULTS

Owing to potential faults, safety circuits may become less effective, which results in lower safety levels. You should check the operational condition of the appliance devices regularly.

5.11 WARNING SIGNS (IF ANY)

The appliance is fitted with warning danger, warning and obligation signs defined in agreement with the Standard relative to the graphical signs to be used on plants. The signs are located in clearly visible positions.



ATTENTION

The warning plates present on the appliance must not be removed.
The user is responsible for replacing warning signs that, owing to wear, become unreadable.

5.12 FALLING OBJECTS

Positioning of the cabinet display parts (i.e. counters, rods and hooks), as also product arrangement inside the cabinet can be the source of potential hazards if not properly performed. Follow the positioning instructions described in this Manual before you place products inside the cabinet, check that the counters are properly fastened, as also the hooks, etc. Do not exceed the maximum load limit. Do not exceed the maximum load limit. Do not position tilted product on the counters if they are not held in place by their stoppers.

5.13 COOLING

During different operations to perform on the counter, such as cleaning or loading goods, it is necessary to handle products and/or counter parts at a low temperature with the risk of "cold injury" for the operators and/or accidental slipping hazard. Follow the safety regulations in the place where the cabinet is installed; more specifically, be sure to always use the right PPE (especially gloves).

5.14 FOODSTUFFS SAFETY (PACKAGED PRODUCTS)

The refrigerator cabinet described herein is meant to be used to display packaged products. As such, it is not designed for direct contact between the foodstuffs and display surfaces. If the foodstuffs do accidentally make contact with the surfaces and for a rather long time, the product may be contaminated. Follow the guidelines on how to use the cabinet. If a product package breaks, remove it from the cabinet and clean, if necessary.

6.DISPOSAL OF WASTE MATERIAL

During normal operation, the appliance does not generate any environmental contamination. At the end of its life cycle, or if it is necessary to proceed to permanent decommissioning, we recommend following the procedures below:

DISPOSAL (USER)



The symbol, applied to either the product or its packaging, indicates that the product should not be considered as normal domestic waste, but should be taken to a waste collection point for the recycling of electrical and electronic appliances. The correct disposal of this product contributes to preventing potential negative consequences that might derive from an inadequate disposal of the product. For detailed information about recycling this product, contact your council, your local waste collection service or the store where you purchased the product.

PROCEDURE FOR DISPOSAL and RECYCLING AT THE END OF APPLIANCE LIFE SPAN (AUTHORISED BODIES)

- Switch off the equipment and unplug the power supply cable.
- Remove the lamps (if installed). These should be disposed of separately.
- Remove the power units and the electronic cards. These should be disposed of separately.
- Remove all the independent parts (grids, casings, profiles, etc.) and group them according to shared features in order to access the heat exchangers, pipes, cables, etc. and be careful not to damage the cooling circuit.
- Remove all mobile parts (doors, sliding doors, glass parts, etc.) and group the various materials according to their features.
- Check the type of refrigerant on the plate positioned inside the counter; extract the refrigerant and dispose of it through authorised services.
- Disconnect the evaporator, condenser, compressor, pipes and fans. These are made of copper, aluminium, steel and plastic and should therefore be disposed of separately.
- On removal of all guards and the various components from the frame, separate the different types of material making up the appliance (plastic, sheet steel, polyurethane, copper, etc) and collect them separately.



All recyclable materials and waste should be processed and recycled by professionals, in compliance with the laws in the country in question. The company responsible for recycling the materials should be registered and certified as a waste disposal service in accordance with the country in question.



ATTENTION

Illegal disposal of the product by the owner will result in administrative sanctions as required by current laws. Disposal of the product should comply with current laws on the disposal of coolant liquids and mineral oils.



IMPORTANT

If the crossed wheeled bin sign is not present on the appliance, it means that the disposal of the product is not the manufacturer's responsibility. In this case, the Regulations regarding the disposal of waste in force are valid.



ADDITIONAL INFORMATION

Further information on the disposal of liquid coolant, oils and other substances is available on the safety data sheet corresponding to the substance itself. In order to dispose of foamed assemblies, remember that the polyurethane foams used are CFC, HFC and HCFC free.

7. INSTALLATION

This manual supplies the information necessary for correct unpacking, procedures for positioning and connection to mains electricity.

7.1 STORAGE AND UNPACKING

The appliance, with or without the packaging, should be carefully stored inside warehouses or in areas away from the elements and direct sunlight, at a temperature between **0** and **+40** °C.

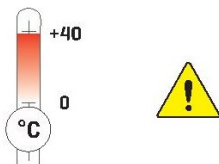



The movement of the apparatus should only be carried out using a fork lift of a suitable power for the weight of the same and manoeuvred by qualified personnel: during such operations the equipment must be positioned on the supplied pallet.

Unplug the appliance from removing the screws that lock the pallet.

All packaging materials are recyclable and should be disposed of in accordance with local regulations.

Please destroy "plastic" bags to prevent them from becoming hazardous to children (suffocation).

7.2 ENVIRONMENTAL CONDITIONS

ATTENTION

A dry room that can be ventilated is the suitable location for the appliance's installation. There should be a good air flow around the compressor/condensing unit. Therefore the area around the unit should not be obstructed by boxes or other objects.



Place the equipment away from sources of heat (radiators, heaters of any kind, etc.) and far from the influence of continuous air movement (caused by fans, air conditioning units, etc.). If it is unavoidable to install near a heat source, use a suitable insulating plate,

Also avoid exposure to direct sunlight; all of this causes the temperature inside the refrigerated compartment to rise with negative consequences on operation and energy consumption. Do not use the appliance outdoors and do not leave it exposed to rain.

7.3 INSTALLATION



ATTENTION

It is fundamental to respect the distances indicated (mm) for correct installation of the appliance.

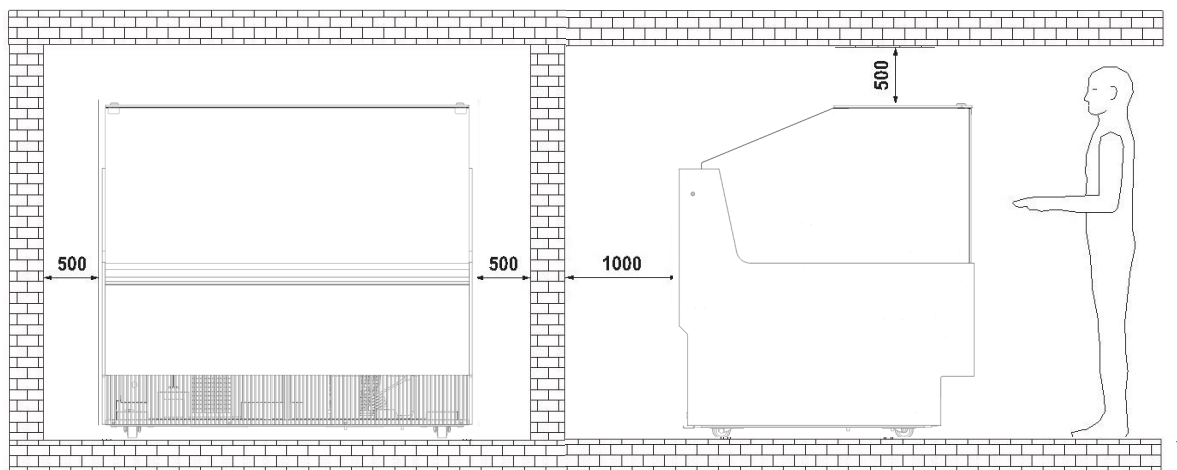

7.4 ELECTRIC CONNECTION

ATTENTION

Check that the network voltage matches the one displayed on the identification plate of the appliance, and that the power is adequate. Check on the socket that the power supply voltage provides rated voltage ($\pm 10\%$) when you start up the compressor. The plug should be directly connected to the electrical socket. It is forbidden to connect the plug to the socket by means of multiple socket extensions or adaptors. The plant power supply socket must be fitted with a disconnection device from the mains electricity (dimensioned to the load and in compliance with Standards in force), which guarantees complete disconnection in category III (3) over-voltage conditions and therefore protects the circuits against earth faults, overloads and short circuits. Do not route the electricity cable in passageways.



ATTENTION

Earthing is necessary and mandatory by law.



7.5 POSITIONING / LEVELLING

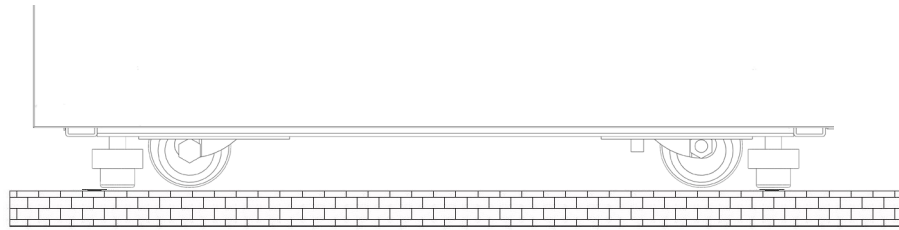

WARNING
HEIGHT ADJUSTABLE FEET

The equipment is set up with adjustable leveling feet in height. It is **absolutely necessary** after placement to level the equipment on the floor.

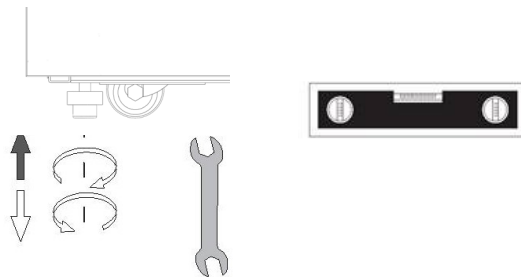

WARNING

After it is positioned, the appliance must be stabilised on the floor by adjusting the feet until they donot rest on the wheels.

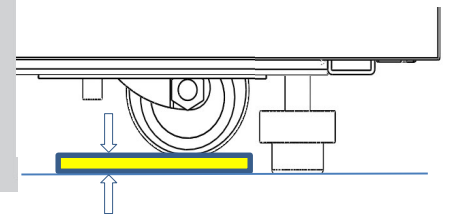

8. MAINTENANCE

The **Staff in charge of the appliance** must control and respect the expiry dates for maintenance, given in the table below, calling the authorised **Technical After-sales assistance** when indicated.

OPERATION	FREQUENCY				ORDINARY	EXTRAORDINARY	PERSONNEL AUTHORISED
	Depending on the Use and Necessity	Monthly	Six-month	Annual			
CLEANING THE EXTERNAL SURFACES	x				x		USER
CLEANING THE ACCESSIBLE INTERNAL PARTS (without the use tools)	x				x		
CONTROL POWER SUPPLY CABLE,PLUGS AND/OR ELECTRICAL SOCKETS			x		x		
INTEGRITY CONTROL SEAL		x			x		
FILTER CLEANING CONDENSING UNIT(whenever present)			x		x		TECHNICAL ASSISTANCE
CLEANING THE DEFROSTING WATER COLLECTION TRAY	x				x		
CONDENSER CLEANING	x				x		

CHECK COMPRESSORE OIL LEVEL(whenever present)					x	
AIR TANK DRAINING(whenever present)				x	x	
CONTROL PNEUMATIC CONNECTIONS(whenever present)				x	x	
INTEGRITY CONTROL PIPE COOLING SYSTEM				x	x	
INSPECTION OF CABLES INTERNAL CONNECTIONS AND POWER				x	x	
CLEANING CONDENSATE DRAINING SPONGES (whenever present)				x	x	
LAMP/LED REPLACEMENT(whenever present)						x
CONTROL PANEL REPLACING (electronic control unit-thermostat-etc)						x
REPLACEMENT POWER SUPPLY CABLE PLUGS AND/OR ELECTRICAL SOCKETS						x

ATTENTION:

After all maintenance it is **mandatory** to perform all electric safety tests in agreement with the IEC EN 50106 Standard.

9. FAULTS - TECHNICAL AFTER-SALES ASSISTANCE

If the appliance is not working properly or stops working, **before contacting** the Customer support centre, check the following:

THE EQUIPMENT DOES NOT WORK		
CAUSE	SOLUTION	PERSONNEL AUTHORISED
Blown protective fuse	Find the cause of the intervention of the switch first, and then replace the new fuse	USER
The master switch is open	Close the master switch	
The plug is not inserted	Insert the plug	
Electrical black-out	If the black-out should be prolonged, transfer the product into an appropriate cold storage container.	
THE INTERNAL TEMPERATURE IS NOT LOW ENOUGH		
CAUSE	SOLUTION	PERSONNEL AUTHORISED
Evaporator/s obstructed completely by ice	Carry out an additional defrosting cycle.	USER
Wrong temperature setting	Set the appropriate temperature.	
The appliance is affected by draughts or is exposed to direct or reflected sunlight	Remove any draughts and prevent any direct or reflected sunlight	
Insufficient air flow for cooling to the condenser	Remove anything that may affect air flow inside the condensing unit (paper sheets, cardboard, grids with an insufficient number of holes, etc.).	
Internal fans at standstill or with fans damage		TECHNICAL ASSISTANCE
Internal ventilation is too high		
Thermostat /Electrical base unit not efficient	Replace the electronic control board. If the control unit is set up especially for must R290 refrigerant, it must only be replaced with an original replacement from manufacturer. Replace the temperature probes only after checking which of the two is not operating efficient	
Condenser unit blocked by dust or dirt in general	Clean the condensing unit thoroughly. The air condenser or MAINTENANCE FREE, in particular heavy environments (e.g. presence of dust, the presence of excessive moisture, oiled vapours etc.) in order to avoid performance loss, needs accurate cleaning.	
Insufficient refrigerant load in the cooling system	Find the cause behind the lower amounts of coolant and eliminate it. Top up the coolant. If necessary, empty the system before topping up.	

THE COMPRESSOR DOES NOT START-UP OR OPERATES FOR A FEW MOMENTS		
CAUSE	SOLUTION	PERSONNEL AUTHORISED
No electric power supply to the appliance	Check if there is a power cut. Close the various switches on the power supply line.	USER
Excessively low power voltage	Check that the network voltage of the power supply cable is 220V+/-10%.	
Temperature set too high	If the temperature is higher than the air temperature in the display chamber, the compressor will not start. Set the suited temperature if the current temperature is not low enough.	
Intervention of the maximum pressure switch(where present)	Check the cause of continuous intervention of the maximum pressure switch, which may be: air condenser blocked, condensing fan stopped, ambient temperature too high, pressure switch defective.	TECHNICAL ASSISTANCE

10.1 ALARMS LIST (WHERE PRESENT)

Mess.	Cause	Outputs	Alarm recovery
"P1"	Room probe failure	Compressor output according to "Cy" e "Cn"	Probe alarms P1 and P2 start some seconds after the fault in the related probe; they automatically stop some seconds after the probe restarts normal operation. Check connections before replacing the probe.
"P2"	Evaporator probe failure	Defrost end is timed	
"HA"	Maximum temperature alarm	Outputs unchanged	Temperature alarms HA and LA automatically stop as soon as the temperature returns to normal values.
"LA"	Minimum temperature alarm	Outputs unchanged	
"EA"	External alarm	Outputs unchanged	Alarms EA and CA (with iF=bL) recover as soon as the digital input is disabled
"CA"	Serious external alarm	All outputs OFF	
"dA"	Door Open	Compressor and fans restarts	

10. TECHNICAL SPECIFICATIONS

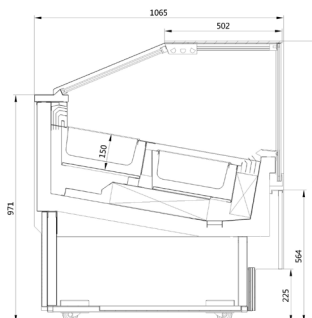
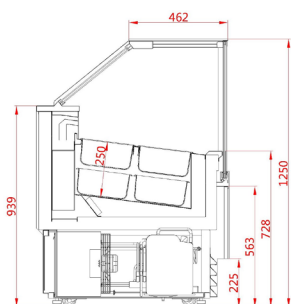

Model	External dimensions			Temperature(°C)	Power supply (V/Hz/Ph)
	Lenght(mm)	Depth(mm)	Height(mm)		
Wow Gelato 12	1283	900	1250	-16/-18	230/50/1

10.1 GLASS



ATTENTION

Is absolutely forbidden to place weights on glass surfaces.

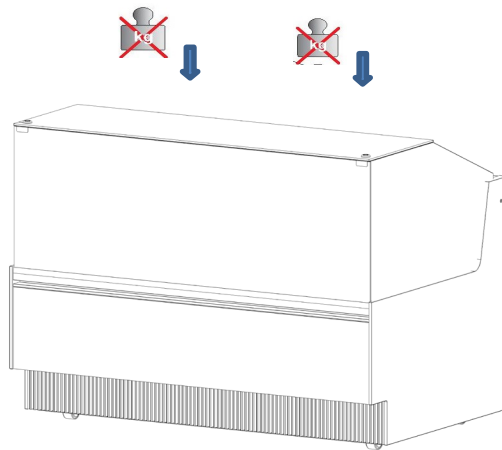

11. CONTROL PANEL

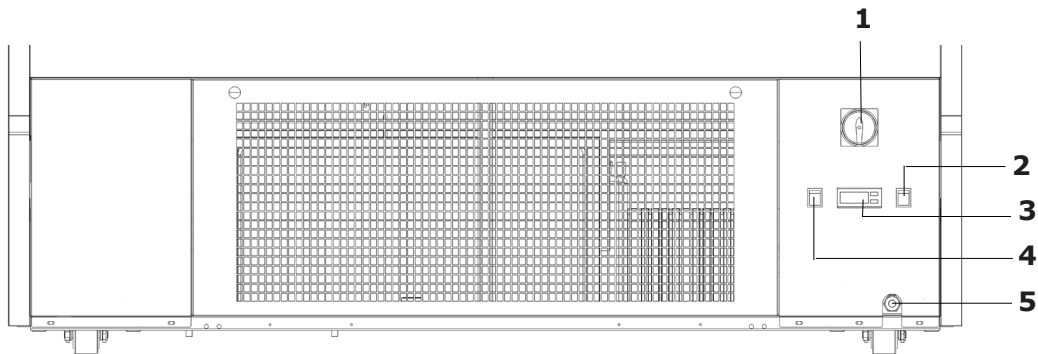

- 1 Main switch.
- 2 Lamp switch.
- 3 Thermostat.
- 4 Cooling switch.
- 5 Power plug.



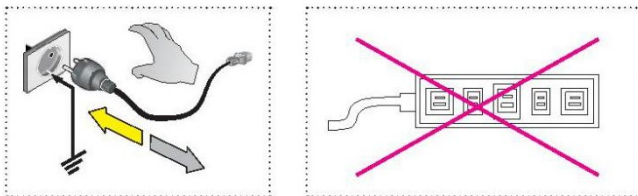

START-UP



Plug the appliance in at the socket supplied by the customer, ensuring that the plug is fitted with an earth contact and that there are no multiple sockets connected to it.



11.1 USER INTERFACE

	<p>SET</p>	To display target set point, in programming mode it selects a parameter or confirm an Operation
		To start a manual defrost
		In programming mode it browses the parameter codes or increases the displayed value
		In programming mode it browses the parameter codes or decreases the displayed value



KEYS COMBINATION	
 + 	To lock or unlock the keyboard
SET + 	To enter in programming mode
SET + 	To return to room temperature display

LED	MODE	SIGNIFICATO
	On	Compressor enabled
	Flashing	Anti short cycle delay enabled (AC parameter)
	On	Defrost in progress
	Flashing	Dripping in progress
	On	Fans output enabled
	Flashing	Fans delay after defrost
°C	On	Measurement unit
	Flashing	Programming mode
°F	On	Measurement unit
	Flashing	Programming mode

HOW TO SEE THE SET POINT

1. Push and immediately release the **SET** key, the set point will be showed;
2. Push and immediately release the **SET** key or wait about 5s to return to normal visualisation.

HOW TO CHANGE THE SETPOINT



1. Push the SET key for more than 2 seconds to change the Set point value;
2. The value of the set point will be displayed and the "°C" or "°F" LED starts blinking;
3. To change the Set value push the  or  arrows.
4. To memorise the new set point value push the SET key again or wait 10s.

HOW TO START A MANUAL DEFROST

Push the **DEF**  key for more than 2 seconds and a manual defrost will start

HOW TO CHANGE A PARAMETER VALUE

To change the parameter's value operate as follows:

1. Enter the Programming mode by pressing the **SET**+ keys for 3s ("°C" or "°F" LED starts blinking).
2. Select the required parameter. Press the "SET" key to display its value
3. Use  or  to change its value.
4. Press "SET" to store the new value and move to the following parameter.



To exit: Press **SET**+ or wait 15s without pressing a key.

NOTE: the set value is stored even when the procedure is exited by waiting the time-out to expire.



HIDDEN MENU

The hidden menu includes all the parameters of the instrument.

HOW TO ENTER THE HIDDEN MENU

1. Enter the Programming mode by pressing the **SET**+ keys for 3s ("°C" or "°F" LED starts blinking).
2. Released the keys, then push again the **SET**+ keys for more than 7s. The L2 label will be displayed immediately followed from the Hy parameter.

NOW YOU ARE IN THE HIDDEN MENU.

3. Select the required parameter.
4. Press the "SET" key to display its value
5. Use  or  to change its value.
6. Press "SET" to store the new value and move to the following parameter.

To exit: Press **SET**+ or wait 15s without pressing a key.



NOTE1: if there aren't any parameter in L1, after 3s the "nP" message is displayed. Keep the keys pushed till the L2 message is displayed.

NOTE2: the set value is stored even when the procedure is exited by waiting the time-out to expire.

HOW TO MOVE A PARAMETER FROM THE HIDDEN MENU TO THE FIRST LEVEL AND VICEVERSA.

Each parameter present in the HIDDEN MENU can be removed or put into "THE FIRST LEVEL" (user level) by pressing **SET**+. In HIDDEN MENU when a parameter is present in First Level the decimal point is on.

TO LOCK THE KEYBOARD

1. Keep pressed for more than 3s the  and  keys.
2. The "OF" message will be displayed and the keyboard will be locked. If a key is pressed more than 3s the "OF" message will be displayed.

TO UNLOCK THE KEYBOARD

Keep pressed together for more than 3s the \wedge and \vee keys till the "on" message will be displayed.

12. CLEANING

The materials listed below must be cleaned as follows:

STAINLESS STEEL

Only use warm water and non-aggressive detergents and then rinse and dry using a soft cloth.

ACRYLIC OR POLYCARBONATE

Wash with lukewarm water, using a soft cloth or a chamois cloth. Do not use abrasive cloths or sponges.

GLASS

Only use products specifically designed for cleaning glass. We do not recommend using tap water, which may leave calcium deposits on the surface of the glass.

12.1 INTERNAL**ATTENTION**

Do not scrape the ice from the walls with pointed tools, the surfaces will be ruined. Do not use high pressure appliances (e.g. steam generators).

1. Remove the product contained in the refrigerated compartment and place it immediately in a special refrigerator conservative to ensure proper storage.
2. Turn off the equipment.

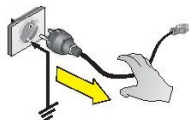

3. Remove accessories manually removable (e.g.. Sliding, grills, ice cream containers, etc).
4. Wait at least 4 to 6 hours, until the ice on the evaporator has melted completely, before proceeding with cleaning operations. We suggest in this regard, you wait for the next day to make sure that the defrosting is completely done. Do not use mechanical devices or other means to accelerate the defrosting process, other than those recommended by the manufacturer.
5. Remove (if present) the drain plug of the tank bottom to drain the defrost water.
6. Clean the side panels and the bottom of the tank using a mild detergent, warm water and a cloth or sponge. Do not use sharp tools. Rinse thoroughly and dry with an absorbent cloth.
7. If the equipment was joined to a floor drain, slide lukewarm water containing a sanitizing solution suited to the specific application. The amount of solution to be used should be such as to ensure a perfect removal of any residual product and proper sanitation along the entire path of the drainage.
8. If the equipment is not joined to a floor drain, follow the procedure referred to above. The rinse water collected in the tank will be positioned inside the base of the apparatus. Clean and disinfect the collection tray.
9. Fit the accessories that were removed (step 3).
10. Turn on the equipment and allow to cool on the bench until it reaches the desired temperature before reintroducing foods.

12.2 CLEAN CONDENSER FILTER

Remove the product contained in the refrigerated compartment and place it immediately in a special refrigerator conservative to ensure proper storage.

Step1: Turn off the Lamp Switch → Cooling Switch → Main switch.

Step2: Open back panel.

Step3: Take out the condenser filter.

Step4: Clean the condenser filter.

Step5: After clean take the filter put in condenser units.

Step6: Close the back panel.

Step7: Turn on the Main switch → Cooling Switch → Lamp Switch.

Step8: Wait temperature arrive -18°C put inside again the gelato.

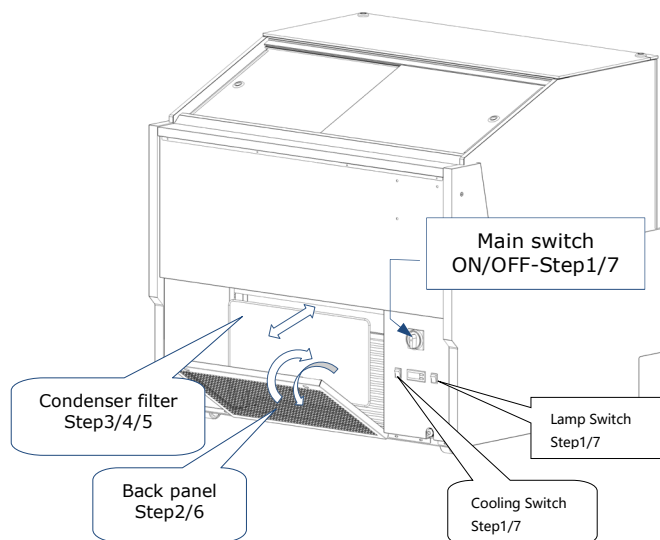

12.3 SLIDING CLOSURE

ATTENTION



Slides should be cleaned periodically with a commercial glass cleaner. To maintain the proper flow dusting and cleaning the chassis daily.

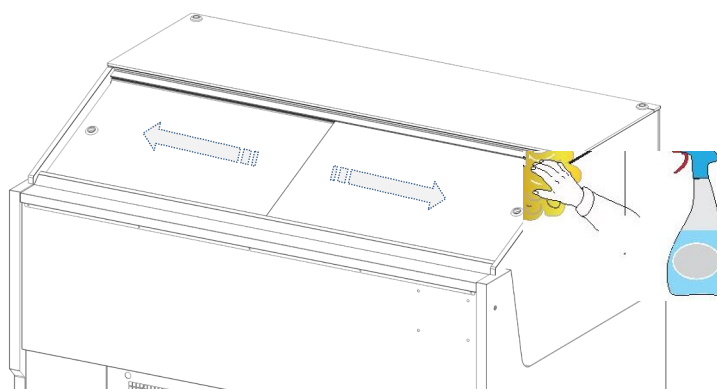

Marketed globally by:

TRUFROST AND BUTLER PRIVATE LIMITED

1215, 12th Floor, Tower B, Emaar Digital Greens, Golf Course Extn. Road,
Sector 61, Gurugram – 122102 (India)

T.+91-7303166766 info@trufrost.com

www.trufrost.com