

TRUFROST & BUTLER



Give your skills
the stage they deserve



Two brands - Trufrost and Butler team up to provide a comprehensive bouquet of products designed to provide a cutting edge to commercial kitchens, cloud kitchens, industrial canteens and QSRs. Products that will cook and cool and let you breathe easy by their tireless performance, extraordinary features and dependable service.

This catalogue however covers only our refrigeration products & solutions marketed under the Trufrost brand, and is dedicated to the professional kitchen planners, facilities planners and a master class of chefs, who through their knowledge, skill, experience, and sheer labour of love, stimulate our senses and bring such joy and happiness into our lives.





Bespoke design

While you may access our individual category wise catalogues by clicking on the QR codes in the facing section, this refrigeration catalogue goes beyond the generally available cookie cutter options for commercial refrigeration and strives to broad base our offering for large kitchen projects that may need some level of customisation. We know that no two kitchens are the same, so our products are designed to adapt to your needs but only to the extent that there is no compromise on the reliability of the core product.



Scan the QR codes given below to download other catalogues for

- 1 Bakeries
Confectionery  

- 2 Commercial Kitchens
Cloud Kitchens 

- 3 Cafés
Patisseries 

- 4 Pizzerias
QSRs 

- 5 Ice Cream Parlours
Juice Bars 

- 6 Resto-bars
Pubs 

- 7 Food Retail
Supermarkets 

- 8 Food Preservation
Cold Storage 



Front-of-house & Back-of-house

Our front-of-house products are specially designed to provide that 'oomph' and X-factor to your ambience without any compromise on quality & reliability. Our products look great and perform well, either front-of-house or back-of-house. Even for back-of-house products, our design philosophy is that functionality does not have to be dull.



Enhancing functionality without any compromise on reliability

- Option of advanced and elegant touch controls
- Energy rated options available
- Stainless Steel 304 inside & outside
- Stainless Steel 304 inside & SS 201 outside
- Option of lockable, heavy-duty castors or adjustable legs
- Glass door option on some models
- Option of GN or EN compatible models
- Provision of drawers in some reach-in cabinet models
- Slim Reach-In Cabinets available for space saving



Energy Rating



Castors



Adjustable legs



Enhancing functionality without any compromise on reliability (refrigerated counters)

- Multiple top surface options
 - Stainless steel
 - Marble
- Set of 2 or 3 drawers instead of doors
- Option of stainless steel shelves
- Compressor options on left or right side
- Option of built-in sink
- Option of back splash & side splash
- Option of overhead shelves
- Pass through units



Overhead shelves

Compressor placement options



Compressor on left



Compressor on right



Compressor at bottom



Remote compressor

Refrigerated counters with variety of depths



Front-of-House

From captivating displays for cakes & confectionary, to inviting wine walls, or an impressive array of induction systems, stunning displays for ice cream, gelato, sushi or tapas, and Italian coffee machines that create a multi-sensory impact on your guests, we have covered everything and more.





Back-of-House

Our back of house equipment pivots around functionality, reliability, ruggedness but without being boring. Backed by contemporary technology, ergonomics and energy efficiency, we use eco friendly refrigerants. For instance, rounded corners, panels with camlocks, slim ceiling mounted evaporators and conformity to stringent hospitality specifications are hallmark of our coldroom design. Our professional stainless steel refrigerators offer energy rated options and ice machines are best in class.



Professional Refrigeration - Energy Rated Series	11
◆ Reach-in Cabinets	
◆ Refrigerated Counters	
◆ Preparation Counters	
Professional Refrigeration - Premia Series	15
◆ Reach-in Cabinets	
◆ Refrigerated Counters	
◆ Saladettes	
◆ Convertible Cold Drawers	
Professional Refrigeration - Snack Series	56
◆ Reach-in Cabinets	
◆ Refrigerated Counters	
Blast Chillers & Freezers	59
Drop-In Refrigeration & Bain Mairie	63
◆ Cooling Wells & Bain Maries	
◆ Frost Tops	
Premium Displays for Confectionery & Chocolate	68
Countertop Displays	72
Bottle Coolers, Back Bars & Beer Dispensers	79
Wine Coolers & Wine Walls	89
Chest Freezers & Coolers with Stainless Steel Top	96
Ice Machines	101
Cold Rooms	104

GN Cabinets (100 mm Insulation)

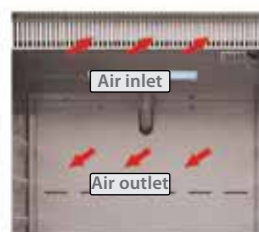

New design air conduct offers better air cycle for more uniform temperature



Stamping side panel instead of shelf support easy for cleaning
Max with 15 longer shelves or pans GN2/1



With bottom shelf gives better air cycle



LED light for better energy efficiency

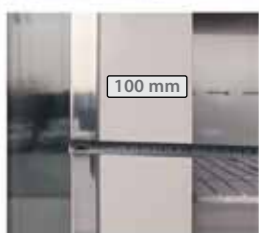

Super thick insulation 100mm.



Automatic fan cut-off system reduces cool air loss and energy consumption



Newest high efficiency variable speed compressor helps save energy



UGN650TN



UGN650TNM



UGN650BT



UGN650BTM

Features

- ◆ HC refrigerant and foam
- ◆ Electronic thermostat and digital LED temperature display for accurate control and easy reading
- ◆ Auto defrosting and auto evaporation of condensation water
- ◆ Magnetic gasket can be replaced without any tools
- ◆ Insulation 100 mm thickness for better energy efficiency
- ◆ Self-closing door
- ◆ Complete structure interior AISI 304 & exterior in stainless steel AISI 430 with round internal edges for easy cleaning

Options

- ◆ Legs
- ◆ Stainless steel shelf
- ◆ Defrost by heating element (for TN)



Technical Specifications

Model	Ext. Dimension WxDxH (mm)	Int. Dimension WxDxH (mm)	Capacity (L)	Temperature (°C)	Energy level	Shelf	Power Supply
UGN650TN	740x875x2090	533x700x1501	560	-2 ~ +8°C	A	3 pcs	230V/50Hz
UGN650BT	740x875x2090	533x700x1501	560	-18 ~ -22°C	B	3 pcs	230V/50Hz
UGN650TNM	740x875x2090	533x700x1501	560	-2 ~ +8°C	A	3 pcs	230V/50Hz
UGN650BTM	740x875x2090	533x700x1501	560	-18 ~ -22°C	B	3 pcs	230V/50Hz

Specifications are subject to change without prior notice due to continuous product development



GN Cabinets (90 mm Insulation)

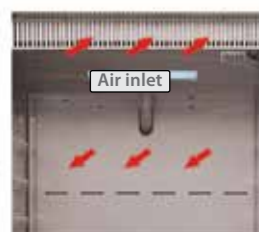

New design air conduct offers better air cycle for more uniform temperature



With bottom shelf gives better air cycle



LED light for better energy efficiency



Super thick insulation 90mm.



Automatic fan cut-off system reduces cool air loss and energy consumption



Newest high efficiency variable speed compressor helps save energy



UGN70TN / UGN70BT



UGN70TNM / UGN70BTM



UGN140TN / UGN140BT



UGN140TNM / UGN140BTM

Features

- ◆ HC refrigerant and foam
- ◆ Electronic thermostat and digital LED temperature display for accurate control and easy reading
- ◆ Auto defrosting and auto evaporation of condensation water
- ◆ Magnetic gasket can be replaced without any tools
- ◆ Insulation 90 mm thickness for better energy efficiency
- ◆ Self-closing door
- ◆ Complete structure interior AISI 304 & exterior in stainless steel AISI 430 with round internal edges for easy cleaning

TN Models

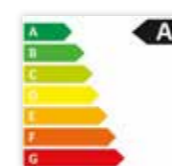

BT Models

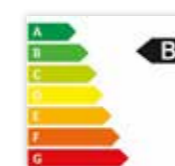

Technical Specifications

Model	Ext. Dimension WxDxH (mm)	Int. Dimension WxDxH (mm)	Capacity (L)	Temperature (°C)	Energy level	Shelf	Power Supply
UGN70TN	740x875x2090	560x700x1501	588	-2 ~ +8°C	A	3 pcs	230V/50Hz
UGN70BT	740x875x2090	560x700x1501	588	-18 ~ -22°C	B	3 pcs	230V/50Hz
UGN140TN	1420x875x2090	1240x700x1501	1300	-2 ~ +8°C	A	6 pcs	230V/50Hz
UGN140BT	1420x875x2090	1240x700x1501	1300	-18 ~ -22°C	B	6 pcs	230V/50Hz
UGN70TNM	740x875x2090	560x700x1501	588	-2 ~ +8°C	A	3 pcs	230V/50Hz
UGN70BTM	740x875x2090	560x700x1501	588	-18 ~ -22°C	B	3 pcs	230V/50Hz
UGN140TNM	1420x875x2090	1240x700x1501	1300	-2 ~ +8°C	A	6 pcs	230V/50Hz
UGN140BTm	1420x875x2090	1240x700x1501	1300	-18 ~ -22°C	B	6 pcs	230V/50Hz

Specifications are subject to change without prior notice due to continuous product development

Options

- ◆ Legs
- ◆ Stainless steel shelf
- ◆ Defrost by heating element (for TN)



GN Counters (60 mm Insulation)

Consumption:
1.028 Kwh/24h



Consumption:
1.415 Kwh/24h



With bottom shelf gives better air cycle



Cleaning Free Condenser



High Efficiency Circle Fan



Automatic fan cut-off system reduces cool air loss and energy consumption



Newest high efficiency variable speed compressor helps save energy

Features

- ◆ HC refrigerant and foam
- ◆ Electronic thermostat and digital LED temperature display for accurate control and easy reading
- ◆ Auto defrosting and auto evaporation of condensation water
- ◆ Magnetic gasket can be replaced without any tools
- ◆ Insulation 60 mm thickness for better energy efficiency
- ◆ Self-closing door
- ◆ Complete structure interior AISI 304 & exterior in stainless steel AISI 430 with round internal edges for easy cleaning

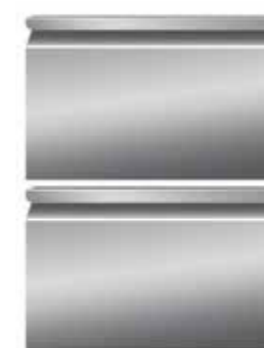

Set of 2 drawers optional



Set of 3 drawers optional

Options

- ◆ Casters
- ◆ Stainless steel shelf
- ◆ Defrost by heating element (for TN)

Technical Specifications

Model	Ext. Dimension WxDxH (mm)	Int. Dimension WxDxH (mm)	Capacity (L)	Temperature (°C)	Energy level	Shelf	Power Supply
UGN2100TN	1360x700x860	795x580x560	314	-2 ~ +8°C	A	2 pcs	230V/50Hz
UGN3100TN	1795x700x860	1230x580x560	465	-2 ~ +8°C	A	3 pcs	230V/50Hz

Specifications are subject to change without prior notice due to continuous product development





FC-S91



AL plate evaporator as inner



With bottom shelf gives better air cycle



High Efficiency Circle Fan



Super thick 45mm insulation for energy efficiency

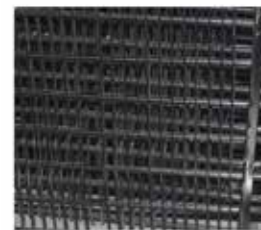

Cleaning Free Condenser



Newest high efficiency variable speed compressor helps save energy



Set of 2 drawers optional



Features

- ◆ HC free refrigerant and foam
- ◆ Electronic thermostat and digital LED temperature display for accurate control and easy reading
- ◆ Auto defrosting and auto evaporation of condensation water
- ◆ Magnetic gasket can be replaced without any tools
- ◆ 45mm thickness foam
- ◆ AISI 304 stainless steel framework construction
- ◆ Bottom with round edges for easy cleaning
- ◆ Shelf and shelf support are designed to accommodate 1 number of GN 1/1 in pan size

Technical Specifications

Model	Ext. Dimension WxDxH (mm)	Int. Dimension WxDxH (mm)	Capacity (L)	Temperature (°C)	Energy level	Shelf	Power Supply
FC-S91	900x700x870	830x595x456	257	-2 ~ +8°C	A	2 pcs	230V/50Hz

Specifications are subject to change without prior notice due to continuous product development



Options

- ◆ Casters
- ◆ Stainless steel shelf
- ◆ Set drawers instead of doors
- ◆ Lamp



GN-650TN/GN-650BT



GN-1410TN/GN-1410BT



GN-650TNM/GN-650BTM



GN-1410TNM/GN-1410BTM

Features

- ◆ HC free refrigerant and foam
- ◆ Electronic thermostat and digital LED temperature display for accurate control and easy reading
- ◆ Ventilated refrigeration compartment gives a better air circulation
- ◆ Auto defrosting and auto evaporation of condensation water
- ◆ Magnetic gasket can be replaced without any tools
- ◆ Insulation 60 mm thickness for better energy efficiency
- ◆ Self-closing door
- ◆ Complete structure interior&. exterior in stainless steel AISI 304 with round internal edges for easy cleaning
- ◆ Shelf and shelf support are designed to accommodate 2 numbers of GN 1/1 in pan size

Options

- ◆ Legs
- ◆ Defrost by heating element (for TN)
- ◆ Stainless steel shelf



Technical Specifications



Model	Ext. Dimension WxDxH (mm)	Int. Dimension WxDxH (mm)	Capacity (L)	Temperature (°C)	Shelf	Power Supply
GN650TN	740x830x2010	624x700x1397	685	-2 ~ +8°C	3 pcs	230V/50Hz
GN650BT	740x830x2010	624x700x1397	685	-18 ~ -22°C	3 pcs	230V/50Hz
GN1410TN	1480x830x2010	1364x700x1410	1476	-2 ~ +8°C	6 pcs	230V/50Hz
GN1410BT	1480x830x2010	1364x700x1410	1476	-18 ~ -22°C	6 pcs	230V/50Hz
GN650TNM	740x830x2010	624x700x1397	685	-2 ~ +8°C	3 pcs	230V/50Hz
GN650BTM	740x830x2010	624x700x1397	685	-18 ~ -22°C	3 pcs	230V/50Hz
GN1410TNM	1480x830x2010	1364x700x1410	1476	-2 ~ +8°C	6 pcs	230V/50Hz
GN1410BTM	1480x830x2010	1364x700x1410	1476	-18 ~ -22°C	6 pcs	230V/50Hz

Specifications are subject to change without prior notice due to continuous product development



GN-650TNG



GN-1410TNG

Features

- ◆ HC free refrigerant and foam
- ◆ Electronic thermostat and digital LED temperature display for accurate control and easy reading
- ◆ Ventilated refrigeration compartment gives a better air circulation
- ◆ Auto defrosting and auto evaporation of condensation water
- ◆ Magnetic gasket can be replaced without any tools
- ◆ Insulation 60 mm thickness for better energy efficiency
- ◆ Self-closing door
- ◆ Complete structure interior&. exterior in stainless steel AISI 304 with round internal edges for easy cleaning
- ◆ Shelf and shelf support are designed to accommodate 2 numbers of GN 1/1 in pan size

Options

- ◆ Legs
- ◆ Defrost by heating element (for TN)
- ◆ Stainless steel shelf

Technical Specifications



Model	Ext. Dimension WxDxH (mm)	Int. Dimension WxDxH (mm)	Capacity (L)	Temperature (°C)	Shelf	Power Supply
GN650TNG	740x810x2010	624x700x1397	685	-2 ~ +8°C	3 pcs	230V/50Hz
GN1410TNG	1480x810x2010	1364x700x1410	1476	-2 ~ +8°C	6 pcs	230V/50Hz

Specifications are subject to change without prior notice due to continuous product development



GN-600TNV/GN600BTV



GN-1200TNV/GN-1200BTV



GN-600TNVM/GN600BTVM



GN-1200TNVM/GN-1200BTVM

Features

- ◆ HC free refrigerant and foam
- ◆ Electronic thermostat and digital LED temperature display for accurate control and easy reading
- ◆ Ventilated refrigeration compartment gives a better air circulation
- ◆ Auto defrosting and auto evaporation of condensation water
- ◆ Magnetic gasket can be replaced without any tools
- ◆ Insulation 60 mm thickness for better energy efficiency
- ◆ Self-closing door
- ◆ Complete structure interior&. exterior in stainless steel AISI 304 with round internal edges for easy cleaning
- ◆ Shelf and shelf support are designed to accommodate 2 numbers of GN 1/1 in pan size

Options

- ◆ Legs
- ◆ Defrost by heating element (for TN)
- ◆ Stainless steel shelf



Technical Specifications



Model	Ext. Dimension WxDxH (mm)	Int. Dimension WxDxH (mm)	Capacity (L)	Temperature (°C)	Shelf	Power Supply
GN600TNV	680x855x2000	560x680x1380	537	-2 ~ +8°C	3 pcs	230V/50Hz
GN600BTV	680x855x2000	560x680x1380	537	-18 ~ -22°C	3 pcs	230V/50Hz
GN600TNVM	680x855x2000	560x680x1380	537	-2 ~ +8°C	3 pcs	230V/50Hz
GN600BTVM	680x855x2000	560x680x1380	537	-18 ~ -22°C	3 pcs	230V/50Hz
GN1200TNV	1340x855x2000	1220x680x1380	1173	-2 ~ +8°C	6 pcs	230V/50Hz
GN1200BTV	1340x855x2000	1220x680x1380	1173	-18 ~ -22°C	6 pcs	230V/50Hz
GN1200TNVM	1340x855x2000	1220x680x1380	1173	-2 ~ +8°C	6 pcs	230V/50Hz
GN1200BTVM	1340x855x2000	1220x680x1380	1173	-18 ~ -22°C	6 pcs	230V/50Hz

Specifications are subject to change without prior notice due to continuous product development



GN-600TNVG/GN600BTVG



GN-1200TNVG/GN-1200BTVG



GN600TNVGM



GN-1200TNVGM

Features

- ◆ HC free refrigerant and foam
- ◆ Electronic thermostat and digital LED temperature display for accurate control and easy reading
- ◆ Auto defrosting and auto evaporation of condensation water
- ◆ Magnetic gasket can be replaced without any tools
- ◆ Insulation 60 mm thickness for better energy efficiency
- ◆ Self-closing door
- ◆ Heating element conceal in door frame to eliminate any condensation
- ◆ Complete structure interior&. exterior in stainless steel AISI 304 with round internal edges for easy cleaning
- ◆ Shelf and shelf support are designed to accommodate GN 2/1 in pan size

Options

- ◆ Legs
- ◆ Stainless steel shelf

Technical Specifications



Model	Ext. Dimension WxDxH (mm)	Int. Dimension WxDxH (mm)	Capacity (L)	Temperature (°C)	Shelf	Power Supply
GN600TNVG	680x835x2000	560x680x1380	537	+2 ~ +8°C	3 pcs	230V/50Hz
GN600BTVG	680x835x2000	560x680x1380	537	-18 ~ -22°C	3 pcs	230V/50Hz
GN600TNVGM	680x835x2000	560x680x1380	537	+2 ~ +8°C	3 pcs	230V/50Hz
GN1200TNVG	1340x835x2000	1220x680x1380	1173	+2 ~ +8°C	6 pcs	230V/50Hz
GN1200BTVG	1340x835x2000	1220x680x1380	1173	-18 ~ -22°C	6 pcs	230V/50Hz
GN1200TNVGM	1340x835x2000	1220x680x1380	1173	+2 ~ +8°C	6 pcs	230V/50Hz

Specifications are subject to change without prior notice due to continuous product development



GN600TN FISH



140 FISH

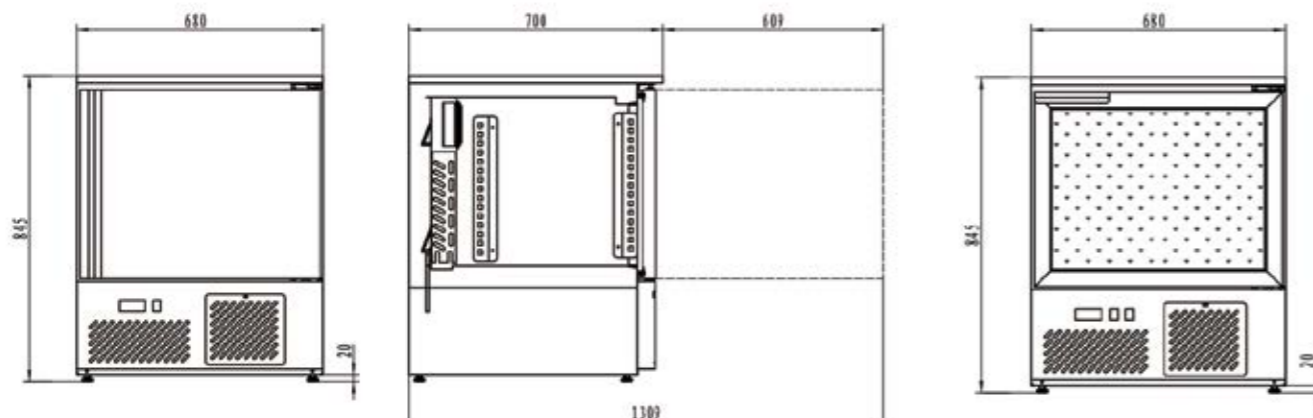

G-140PT / G-140NT/ G-140 FISH

G-140PTG

Features

- ◆ HC free refrigerant and foam
- ◆ Electronic thermostat and digital LED temperature display for accurate control and easy reading
- ◆ Magnetic gasket can be replaced without any tools
- ◆ Insulation 60 mm thickness for better energy efficiency
- ◆ Self-closing door
- ◆ Heating element conceal in door frame to eliminate any condensation
- ◆ Complete structure interior & exterior in stainless steel AISI 304 with round internal edges for easy cleaning
- ◆ Shelf and shelf support are designed to accommodate GN2/1 in pan size in models GN600TN FISH & GN600STN FISH
- ◆ Shelf and shelf support are designed to accommodate 460x530x100mm in pan size in model 140FISH

Options

- ◆ Casters
- ◆ Stainless steel shelf

Technical Specifications

Model	Ext. Dimension WxDxH (mm)	Int. Dimension WxDxH (mm)	Capacity (L)	Temperature (°C)	Shelf	Power Supply	Cooling mode
GN600TN FISH	680x810x2000	560x680x1380	537	-5 ~ 0°C	7pcs Fish Pan 400x600mm	230V/50Hz	Static
GN600STN FISH	680x810x1880	560x680x1380	537	-5 ~ 0°C	7pcs Fish Pan 400x600mm	230V/50Hz	Static
140 FISH	680x700x845	560x500x475	150	-4 ~ +4°C	3 pcs Pan(530X460X100mm)	230V/50Hz	

Specifications are subject to change without prior notice due to continuous product development





GN600DTV



GN1200DTV

Frozen & chilled in one machine



Features

- ◆ HC free refrigerant and foam
- ◆ Electronic thermostat and digital LED temperature display for accurate control and easy reading
- ◆ Magnetic gasket can be replaced without any tools
- ◆ Insulation 60 mm thickness for better energy efficiency
- ◆ Self-closing door
- ◆ Heating element conceal in door frame to eliminate any condensation
- ◆ Complete structure interior & exterior in stainless steel AISI 304 with round internal edges for easy cleaning
- ◆ Shelf and shelf support are designed to accommodate GN2/1 in pan size

Options

- ◆ Casters
- ◆ Stainless steel shelf

Technical Specifications



Model	Ext. Dimension WxDxH (mm)	Int. Dimension WxDxH (mm)	Capacity (L)	Temperature (°C)	Shelf	Power Supply	Cooling mode
GN600DTV	680x855x2000	Chiller 560x680x650	129	-2 ~ +8°C	2pcs	230V/50Hz	Ventilated
	1340x855x2000	Freezer 560x680x650	129	-18 ~ -22°C	4pcs	230V/50Hz	Ventilated
GN1200DTV	1340x835x2000	Chiller 560x680x1380	537	-2 ~ +8°C	4pcs	230V/50Hz	Ventilated
	1340x835x2000	Freezer 560x680x1380	537	-18 ~ -22°C	4pcs	230V/50Hz	Ventilated

Specifications are subject to change without prior notice due to continuous product development



GN350TN / GN350BT



GN350 3D TN

Features

- ◆ HC free refrigerant and foam
- ◆ Electronic thermostat and digital LED temperature display for accurate control and easy reading
- ◆ Ventilated refrigeration compartment gives a better air circulation
- ◆ Auto defrosting and auto evaporation of condensation water
- ◆ Magnetic gasket can be replaced without any tools
- ◆ Insulation 60 mm thickness for better energy efficiency
- ◆ Self-closing door
- ◆ Complete structure interior & exterior in stainless steel AISI 304 with round internal edges for easy cleaning
- ◆ Shelf and shelf support are designed to accommodate 1 number of GN 1/1 in pan size

Options

- ◆ Casters
- ◆ Stainless steel shelf

Technical Specifications



Model	Ext. Dimension WxDxH (mm)	Int. Dimension WxDxH (mm)	Capacity (L)	Temperature (°C)	Shelf	Power Supply
GN350TN	484x735x2010	364x580x1390	350	-2 ~ +8°C	3 pcs	230V/50Hz
GN350BT	484x735x2010	364x580x1390	350	-18 ~ -24°C	3 pcs	230V/50Hz
GN350 3D TN	484x735x2010	364x580x1390	350	-2 ~ +8°C	1 pcs	230V/50Hz

Specifications are subject to change without prior notice due to continuous product development



PA800TN / PA800BT



GE800BT

Features

- ◆ HC free refrigerant and foam
- ◆ Electronic thermostat and digital LED temperature display for accurate control and easy reading
- ◆ Ventilated refrigeration compartment gives a better air circulation
- ◆ Auto defrosting and auto evaporation of condensation water
- ◆ Magnetic gasket can be replaced without any tools
- ◆ Self-closing door
- ◆ Heating element conceal in door frame to eliminate any condensation
- ◆ Complete structure interior & exterior in stainless steel AISI 304 with round internal edges for easy cleaning
- ◆ Design for 600mm x 800mm shelf

Options

- ◆ Casters
- ◆ Stainless steel shelf



Technical Specifications



Model	Ext. Dimension WxDxH (mm)	Int. Dimension WxDxH (mm)	Capacity (L)	Temperature (°C)	Shelf	Power Supply
PA800TN	740x990x2010	624x860x1390	852	+2 ~ +8°C	-	230V/50Hz
PA800BT	740x990x2010	624x860x1390	852	-18 ~ -22°C	-	230V/50Hz
GE800BT	740x990x2010	624x860x1390	852	-18 ~ -22°C	10 pcs	230V/50Hz

Specifications are subject to change without prior notice due to continuous product development



PA800TN / PA800BT

Features

- ◆ HC free refrigerant and foam
- ◆ Electronic thermostat and digital LED temperature display for accurate control and easy reading
- ◆ Ventilated refrigeration compartment gives a better air circulation
- ◆ Auto defrosting and auto evaporation of condensation water
- ◆ Insulation 80 mm thickness
- ◆ Complete structure interior & exterior in stainless steel AISI 304 with round internal edges for easy cleaning
- ◆ Suitable for Trolleys:GN1 / 1/GN2/1 / 400mmx600mm
- ◆ HACCP compliant (every model)
- ◆ Smart automatic DEFROSTING
- ◆ +43°C tropicalized unit

Models Range

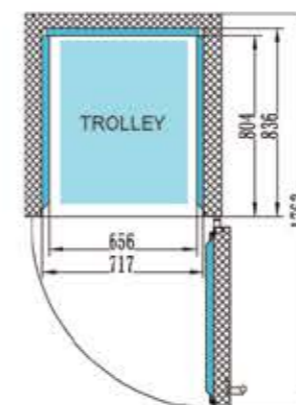

RI1

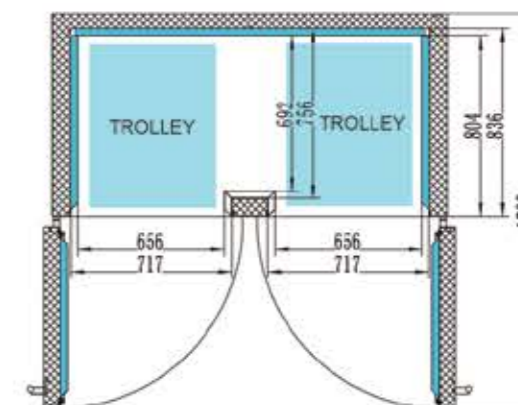

RI2

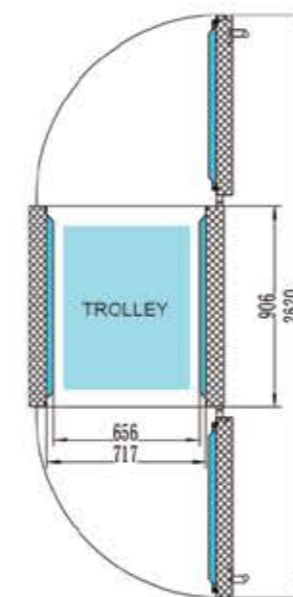

RT1

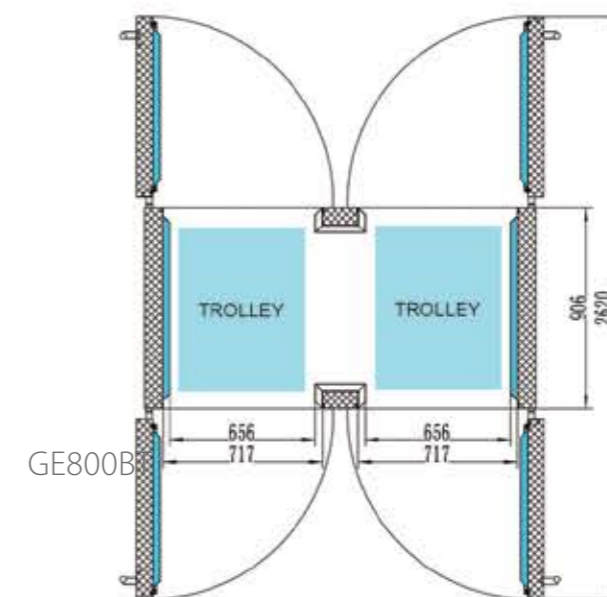

RT2

GE800B

LOAD CAPACITY Trolleys Not Included

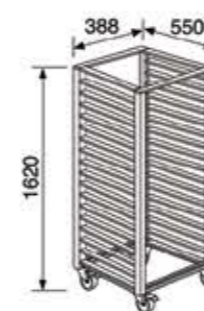

GN 1/1 TROLLEY 20 TRAYS

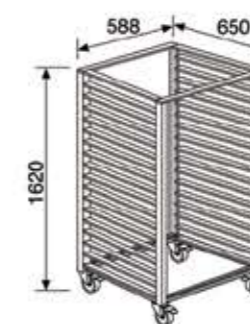

GN 2/1 TROLLEY 20 TRAYS

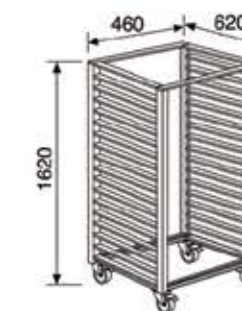

60x40 TROLLEY 20 TRAYS

Pass Through Models



RI 1

RI 2

RT 1

RT 2



Technical Specifications



Model	Ext. Dimension WxDxH (mm)	Int. Dimension WxDxH (mm)	GN1/1 Trolleys	GN2/1 or 60X40 Trolleys (pcs)	Temperature (°C)	Power Supply
RI1	880x1070x2200	656x787x1770	2 Pcs	1	+2 ~ +10°C	230V/50Hz
RI2	1760x1070x2200	1536x787x1770	4 Pcs	2	+2 ~ +10°C	230V/50Hz
RT1	880x1234x2200	656x873x1770	2 Pcs	1	+2 ~ +10°C	230V/50Hz
RT2	1760x1234x2200	1536x873x1770	4 Pcs	2	+2 ~ +10°C	230V/50Hz

Specifications are subject to change without prior notice due to continuous product development

A refrigerated table
for every need





GN1100TN / GN1100BT



GN2100TN / GN2100BT



GN3100TN / GN3100BT



GN4100TN / GN4100BT

Features

- ◆ HC free refrigerant and foam
- ◆ Electronic thermostat and digital LED temperature display for accurate control and easy reading
- ◆ Ventilated refrigeration compartment gives a better air circulation
- ◆ Auto defrosting and auto evaporation of condensation water
- ◆ Magnetic gasket can be replaced without any tools
- ◆ Insulation 60 mm thickness
- ◆ Self-closing door
- ◆ Heating element conceal in door frame to eliminate any condensation
- ◆ Complete structure interior & exterior in stainless steel AISI 304 with round internal edges for easy cleaning
- ◆ Design to accommodate 1 number of GN 1/1 pan size

Options

- ◆ Casters
- ◆ Stainless steel shelf
- ◆ Set drawers instead of doors
- ◆ Lamp



Technical Specifications

Model	Ext. Dimension WxDxH (mm)	Int. Dimension WxDxH (mm)	Capacity (L)	Temperature (°C)	Shelf	Power Supply
GN1100TN	925x700x860	360x580x560	124	-2 ~ +8°C	1 pcs	230V/50Hz
GN1100BT	925x700x860	360x580x560	124	-10 ~ -20°C	1 pcs	230V/50Hz
GN2100TN	1360x700x860	795x580x560	314	-2 ~ +8°C	2 pcs	230V/50Hz
GN2100BT	1360x700x860	795x580x560	314	-10 ~ -20°C	2 pcs	230V/50Hz
GN3100TN	1795x700x860	1230x580x560	465	-2 ~ +8°C	3 pcs	230V/50Hz
GN3100BT	1795x700x860	1230x580x560	465	-10 ~ -20°C	3 pcs	230V/50Hz
GN4100TN	2230x700x860	1665x580x560	616	-2 ~ +8°C	4 pcs	230V/50Hz
GN4100BT	2230x700x860	1665x580x560	616	-10 ~ -20°C	4 pcs	230V/50Hz

Specifications are subject to change without prior notice due to continuous product development





GN2200TN / GN2200BT



GN3200TN / GN3200BT



GN4200TN / GN4200BT



Features

- ◆ HC free refrigerant and foam
- ◆ Electronic thermostat and digital LED temperature display for accurate control and easy reading
- ◆ Ventilated refrigeration compartment gives a better air circulation
- ◆ Auto defrosting and auto evaporation of condensation water
- ◆ Magnetic gasket can be replaced without any tools
- ◆ Insulation 60 mm thickness
- ◆ Self-closing door
- ◆ Heating element conceal in door frame to eliminate any condensation
- ◆ Complete structure interior & exterior in stainless steel AISI 304 with round internal edges for easy cleaning
- ◆ Design to accommodate 1 number of GN 1/1 pan size

Options

- ◆ Casters
- ◆ Stainless steel shelf
- ◆ Set drawers instead of doors
- ◆ Lamp

Technical Specifications



Model	Ext. Dimension WxDxH (mm)	Int. Dimension WxDxH (mm)	Capacity (L)	Temperature (°C)	Shelf	Power Supply
GN2200TN	1360×700×960	795×580×560	314	-2 ~ +8°C	2 pcs	230V/50Hz
GN2200BT	1360×700×960	795×580×560	314	-10 ~ -20°C	2 pcs	230V/50Hz
GN3200TN	1795×700×960	1230×580×560	465	-2 ~ +8°C	3 pcs	230V/50Hz
GN3200BT	1795×700×960	1230×580×560	465	-10 ~ -20°C	3 pcs	230V/50Hz
GN4200TN	2230×700×960	1665×580×560	616	-2 ~ +8°C	4 pcs	230V/50Hz
GN4200BT	2230×700×960	1665×580×560	616	-10 ~ -20°C	4 pcs	230V/50Hz

Specifications are subject to change without prior notice due to continuous product development



GN1110TN



GN2120TN



GN3130TN



GN4150TN

Features

- ◆ HC free refrigerant and foam
- ◆ Electronic thermostat and digital LED temperature display for accurate control and easy reading
- ◆ Ventilated refrigeration compartment gives a better air circulation
- ◆ Auto defrosting and auto evaporation of condensation water
- ◆ Magnetic gasket can be replaced without any tools
- ◆ Insulation 60 mm thickness
- ◆ Self-closing door
- ◆ Heating element conceal in door frame to eliminate any condensation
- ◆ Complete structure interior & exterior in stainless steel AISI 304 with round internal edges for easy cleaning
- ◆ Design to accommodate 1 number of GN 1/1 pan size

Options

- ◆ Casters
- ◆ Stainless steel shelf
- ◆ Set drawers instead of doors
- ◆ Lamp

Technical Specifications



Model	Ext. Dimension WxDxH (mm)	Int. Dimension WxDxH (mm)	Capacity (L)	Temperature (°C)	Shelf	Power Supply
GN1110TN	925×700×860	364×580×560	124	-2 ~ +8°C	-	230V/50Hz
GN2110TN	1360×700×860	795×580×560	314	-2 ~ +8°C	1 pc	230V/50Hz
GN3110TN	1795×700×860	1230×580×560	465	-2 ~ +8°C	2 pcs	230V/50Hz
GN4110TN	2230×700×860	1665×580×560	616	-2 ~ +8°C	3 pcs	230V/50Hz
GN2120TN	1360×700×860	795×580×560	314	-2 ~ +8°C	1 pcs	230V/50Hz
GN3120TN	1795×700×860	1230×580×560	465	-2 ~ +8°C	2 pcs	230V/50Hz
GN4120TN	2230×700×860	1665×580×560	616	-2 ~ +8°C	3 pcs	230V/50Hz
GN1130TN	925×700×860	364×580×560	124	-2 ~ +8°C	-	230V/50Hz
GN2130TN	1360×700×860	795×580×560	314	-2 ~ +8°C	1 pc	230V/50Hz
GN3130TN	1795×700×860	1230×580×560	465	-2 ~ +8°C	2 pcs	230V/50Hz
GN4130TN	2230×700×860	1665×580×560	616	-2 ~ +8°C	3 pcs	230V/50Hz
GN2150TN	1360×700×860	795×580×560	314	-2 ~ +8°C	-	230V/50Hz
GN3150TN	1795×700×860	1230×580×560	465	-2 ~ +8°C	1 pcs	230V/50Hz
GN4150TN	2230×700×860	1665×580×560	616	-2 ~ +8°C	2 pcs	230V/50Hz

Specifications are subject to change without prior notice due to continuous product development



GN2100TNG



GN3100TNG



GN4100TNG

Professional Refrigeration / GN Counters with Glass Doors & Back Splash / Premia Series



GN2200TNG



GN3200TNG



GN4200TNG

Features

- ◆ HC free refrigerant and foam
- ◆ Electronic thermostat and digital LED temperature display for accurate control and easy reading
- ◆ Ventilated refrigeration compartment gives a better air circulation
- ◆ Auto defrosting and auto evaporation of condensation water
- ◆ Magnetic gasket can be replaced without any tools
- ◆ Insulation 60 mm thickness
- ◆ Self-closing door
- ◆ Heating element conceal in door frame to eliminate any condensation
- ◆ Complete structure interior & exterior in stainless steel AISI 304 with round internal edges for easy cleaning
- ◆ Design to accommodate 1 number of GN 1/1 pan size

Options

- ◆ Casters
- ◆ Stainless steel shelf
- ◆ Top with splash back
- ◆ Lamp



Technical Specifications

Model	Ext. Dimension WxDxH (mm)	Int. Dimension WxDxH (mm)	Capacity (L)	Temperature (°C)	Shelf	Power Supply
GN2100TNG	1360x700x860	795x580x560	314	-2 ~ +8°C	2 pcs	230V/50Hz
GN2200TNG	1360x700x960	795x580x560	314	-2 ~ +8°C	2 pcs	230V/50Hz
GN3100TNG	1795x700x860	1230x580x560	465	-2 ~ +8°C	3 pcs	230V/50Hz
GN3200TNG	1795x700x960	1230x580x560	465	-2 ~ +8°C	3 pcs	230V/50Hz
GN4100TNG	2230x700x860	1665x580x560	616	-2 ~ +8°C	4 pcs	230V/50Hz
GN4200TNG	2230x700x960	1665x580x560	616	-2 ~ +8°C	4 pcs	230V/50Hz

Specifications are subject to change without prior notice due to continuous product development





C-GN2100TN / C-PA2100TN



C-GN3100TN / C-PA3100TN

Features

- ◆ HC free refrigerant and foam
- ◆ Electronic thermostat and digital LED temperature display for accurate control and easy reading
- ◆ Ventilated refrigeration compartment gives a better air circulation
- ◆ Auto defrosting and auto evaporation of condensation water
- ◆ Magnetic gasket can be replaced without any tools
- ◆ Insulation 60 mm thickness
- ◆ Self-closing door
- ◆ Heating element conceal in door frame to eliminate any condensation
- ◆ Complete structure interior & exterior in stainless steel AISI 304 with round internal edges for easy cleaning
- ◆ Design to accommodate 1 number of GN 1/1 pan size

Options

- ◆ Casters
- ◆ Stainless steel shelf
- ◆ Set drawers instead of doors
- ◆ Lamp



Technical Specifications

Model	Ext. Dimension WxDxH (mm)	Int. Dimension WxDxH (mm)	Capacity (L)	Temperature (°C)	Shelf	Power Supply
C-GN2100TN	1360x700x860	795x560x560	216	-2 ~ +8°C	2 pcs	230V/50Hz
C-GN3100TN	1795x700x860	1230x560x560	324	-2 ~ +8°C	3 pcs	230V/50Hz
C-PA2100TN	1510x800x860	945x660x560	390	-2 ~ +8°C	400x600mm 2 pcs	230V/50Hz
C-PA3100TN	2020x800x860	1455x660x560	580	-2 ~ +8°C	400x600mm 3 pcs	230V/50Hz

Specifications are subject to change without prior notice due to continuous product development





GN1500TN



GN2000TN



GN2500TN



Features

- ◆ HC free refrigerant and foam
- ◆ Electronic thermostat and digital LED temperature display for accurate control and easy reading
- ◆ Ventilated refrigeration compartment gives a better air circulation
- ◆ Auto defrosting and auto evaporation of condensation water
- ◆ Magnetic gasket can be replaced without any tools
- ◆ Insulation 60 mm thickness
- ◆ Self-closing door
- ◆ Heating element conceal in door frame to eliminate any condensation
- ◆ Complete structure interior & exterior in stainless steel AISI 304 with round internal edges for easy cleaning
- ◆ Design to accommodate 1 number of GN 1/1 pan size

Options

- ◆ Casters
- ◆ Stainless steel shelf
- ◆ Set drawers instead of doors
- ◆ Lamp



Technical Specifications

Model	Ext. Dimension WxDxH (mm)	Int. Dimension WxDxH (mm)	Capacity (L)	Temperature (°C)	Shelf	Power Supply
GN1500TN	1505x700x870	925x580x560	353	-2 ~ +8°C	2 pcs	230V/50Hz
GN2000TN	2005x700x870	1425x580x560	523	-2 ~ +8°C	3 pcs	230V/50Hz
GN2500TN	2505x700x870	1925x580x560	694	-2 ~ +8°C	4 pcs	230V/50Hz

Specifications are subject to change without prior notice due to continuous product development





GNS2100TN



GNS3100TN



GNS4100TN

Features

- ◆ HC free refrigerant and foam
- ◆ Electronic thermostat and digital LED temperature display for accurate control and easy reading
- ◆ Ventilated refrigeration compartment gives a better air circulation
- ◆ Auto defrosting and auto evaporation of condensation water
- ◆ Magnetic gasket can be replaced without any tools
- ◆ Insulation 60 mm thickness
- ◆ Self-closing door
- ◆ Heating element conceal in door frame to eliminate any condensation
- ◆ Complete structure interior & exterior in stainless steel AISI 304 with round internal edges for easy cleaning
- ◆ Design to accommodate 1 number of GN 1/1 pan size
- ◆ Sink Size: 400x400x150 mm
- ◆ Faucet not supplied with the machine

Options

- ◆ Casters
- ◆ Stainless steel shelf
- ◆ Set drawers instead of doors
- ◆ Lamp

Technical Specifications

Model	Ext. Dimension WxDxH (mm)	Int. Dimension WxDxH (mm)	Capacity (L)	Temperature (°C)	Shelf	Power Supply
GNS2100TN	1510x700x860	795x580x560	390	-2 ~ +8°C	2 pcs	230V/50Hz
GNS3100TN	2020x700x860	1230x580x560	580	-2 ~ +8°C	3 pcs	230V/50Hz
GNS4100TN	2500x700x860	1665x580x560	760	-2 ~ +8°C	4 pcs	230V/50Hz



Specifications are subject to change without prior notice due to continuous product development



GNS2200TN



GNS3200TN



GNS4200TN

Features

- ◆ HC free refrigerant and foam
- ◆ Electronic thermostat and digital LED temperature display for accurate control and easy reading
- ◆ Ventilated refrigeration compartment gives a better air circulation
- ◆ Auto defrosting and auto evaporation of condensation water
- ◆ Magnetic gasket can be replaced without any tools
- ◆ Insulation 60 mm thickness
- ◆ Self-closing door
- ◆ Heating element conceal in door frame to eliminate any condensation
- ◆ Complete structure interior & exterior in stainless steel AISI 304 with round internal edges for easy cleaning
- ◆ Design to accommodate 1 number of GN 1/1 pan size
- ◆ Sink Size: 400x400x150 mm
- ◆ Faucet not supplied with the machine

Options

- ◆ Casters
- ◆ Stainless steel shelf
- ◆ Set drawers instead of doors
- ◆ Lamp

Technical Specifications



Model	Ext. Dimension WxDxH (mm)	Int. Dimension WxDxH (mm)	Capacity (L)	Temperature (°C)	Shelf	Power Supply
GNS2200TN	1510x700x860	795x580x560	390	-2 ~ +8°C	2 pcs	230V/50Hz
GNS3200TN	2020x700x860	1230x580x560	580	-2 ~ +8°C	3 pcs	230V/50Hz
GNS4200TN	2500x700x860	1665x580x560	760	-2 ~ +8°C	4 pcs	230V/50Hz

Specifications are subject to change without prior notice due to continuous product development





GN2100TN.S



GN3100TN.S



GN4100TN.S

Features

- ◆ HC free refrigerant and foam
- ◆ Electronic thermostat and digital LED temperature display for accurate control and easy reading
- ◆ Ventilated refrigeration compartment gives a better air circulation
- ◆ Auto defrosting and auto evaporation of condensation water
- ◆ Magnetic gasket can be replaced without any tools
- ◆ Insulation 60 mm thickness
- ◆ Self-closing door
- ◆ Heating element conceal in door frame to eliminate any condensation
- ◆ Complete structure interior & exterior in stainless steel AISI 304 with round internal edges for easy cleaning
- ◆ Design to accommodate 1 number of GN 1/1 pan size

Options

- ◆ Casters
- ◆ Stainless steel shelf
- ◆ Set drawers instead of doors
- ◆ Lamp



Technical Specifications

Model	Ext. Dimension WxDxH (mm)	Int. Dimension WxDxH (mm)	Capacity (L)	Temperature (°C)	Shelf	Power Supply
GN2100TN.S	1360×700×1365	795×580×560	314	-2 ~ +8°C	2 pcs	230V/50Hz
GN3100TN.S	1795×700×1365	1230×580×560	456	-2 ~ +8°C	3 pcs	230V/50Hz
GN4100TN.S	2230×700×1365	1665×580×560	616	-2 ~ +8°C	4 pcs	230V/50Hz

Specifications are subject to change without prior notice due to continuous product development



GN2100TN SG / GN2100BT SG



GN3100TN SG / GN3100BT SG



GN4100TN SG / GN4100BT SG

Features

- ◆ HC free refrigerant and foam
- ◆ Electronic thermostat and digital LED temperature display for accurate control and easy reading
- ◆ Ventilated refrigeration compartment gives a better air circulation
- ◆ Auto defrosting and auto evaporation of condensation water
- ◆ Magnetic gasket can be replaced without any tools
- ◆ Insulation 60 mm thickness
- ◆ Self-closing door
- ◆ Heating element conceal in door frame to eliminate any condensation
- ◆ Complete structure interior & exterior in stainless steel AISI 304 with round internal edges for easy cleaning
- ◆ Design to accommodate 1 number of GN 1/1 pan size

Options

- ◆ Casters
- ◆ Stainless steel shelf
- ◆ Set drawers instead of doors
- ◆ Lamp
- ◆ Splash back top



Technical Specifications



Model	Ext. Dimension WxDxH (mm)	Int. Dimension WxDxH (mm)	Capacity (L)	Temperature (°C)	Shelf	Power Supply
GN2100TN SG	1220×700×860	795×580×560	314	-2 ~ +8°C	2 pcs	230V/50Hz
GN2100BT SG	1220×700×860	795×580×560	314	-10 ~ -20°C	2 pcs	230V/50Hz
GN3100TN SG	1655×700×860	1230×580×560	465	-2 ~ +8°C	3 pcs	230V/50Hz
GN3100BT SG	1655×700×860	1230×580×560	465	-10 ~ -20°C	3 pcs	230V/50Hz
GN4100TN SG	2090×700×860	1665×580×560	616	-2 ~ +8°C	4 pcs	230V/50Hz
GN4100BT SG	2090×700×860	1665×580×560	616	-10 ~ -20°C	4 pcs	230V/50Hz

Specifications are subject to change without prior notice due to continuous product development



GN2X2/1



GN3X2/1



GN2X2/1G



GN2X2/1-4D



GN3X2/1-6D



GN3X2/1G

Features

- ◆ HC free refrigerant and foam
- ◆ Electronic thermostat and digital LED temperature display for accurate control and easy reading
- ◆ Ventilated refrigeration compartment gives a better air circulation
- ◆ Auto defrosting and auto evaporation of condensation water
- ◆ Magnetic gasket can be replaced without any tools
- ◆ Insulation 60 mm thickness
- ◆ Self-closing door
- ◆ Heating element conceal in door frame to eliminate any condensation
- ◆ Complete structure interior & exterior in stainless steel AISI 304 with round internal edges for easy cleaning
- ◆ Designed to accommodate 1 number of GN 2/1 pan size

Options

- ◆ Casters
- ◆ Stainless steel shelf
- ◆ Top with splash back
- ◆ Lamp

Technical Specifications



Model	Ext. Dimension WxDxH (mm)	Int. Dimension WxDxH (mm)	Capacity (L)	Temperature (°C)	Shelf	Power Supply
GN2 X 2/1	1770×800×860	1209×680×564	450	-2 ~ +8°C	2 pcs	230V/50Hz
GN2 X 2/1-4D	1770×800×860	1209×680×564	450	-2 ~ +8°C	-	230V/50Hz
GN2 X 2/1G	1770×800×860	1209×680×564	450	-2 ~ +8°C	2 pcs	230V/50Hz
GN3 X 2/1	2410×800×860	1849×680×564	700	-2 ~ +8°C	3 pcs	230V/50Hz
GN3 X 2/1-6D	2410×800×860	1849×680×564	700	-2 ~ +8°C	-	230V/50Hz
GN3 X 2/1G	2410×800×860	1849×680×564	700	-2 ~ +8°C	3 pcs	230V/50Hz

Specifications are subject to change without prior notice due to continuous product development



CM15



CM20



CM25



CM15G



CM20G



CM25G



Features

- ◆ HC free refrigerant and foam
- ◆ Electronic thermostat and digital LED temperature display for accurate control and easy reading
- ◆ Auto defrosting and auto evaporation of condensation water
- ◆ Magnetic gaskets can be replaced without any tools
- ◆ AISI 304 stainless steel framework construction
- ◆ Bottom with round edges for easy cleaning

Options

- ◆ Set drawers instead of doors

Technical Specifications



Model	Ext. Dimension WxDxH (mm)	Int. Dimension WxDxH (mm)	Capacity (L)	Temperature (°C)	Shelf	Power Supply
CM15	1505×600×1020	925×480×710	366	-2 ~ +8°C	2 pcs	230V/50Hz
CM20	2005×600×1020	1425×480×710	543	-2 ~ +8°C	3 pcs	230V/50Hz
CM25	2505×600×1020	1925×480×710	720	-2 ~ +8°C	4 pcs	230V/50Hz
CM15G	1505×600×1020	925×480×710	366	-2 ~ +8°C	2 pcs	230V/50Hz
CM20G	2005×600×1020	1425×480×710	543	-2 ~ +8°C	3 pcs	230V/50Hz
CM25G	2505×600×1020	1925×480×710	720	-2 ~ +8°C	4 pcs	230V/50Hz

Specifications are subject to change without prior notice due to continuous product development



U-GN2100TN



U-GN3100TN



U-GN4100TN



U-GN2140TN



U-GN3160TN



U-GN4180TN



U-GN2100TN-2D



U-GN3100TN-3D



U-GN4100TN-4D



Features

- ◆ HC free refrigerant and foam
- ◆ Electronic thermostat and digital LED temperature display for accurate control and easy reading
- ◆ Ventilated refrigeration compartment gives a better air circulation
- ◆ Auto defrosting and auto evaporation of condensation water
- ◆ Magnetic gasket can be replaced without any tools
- ◆ Insulation 60 mm thickness
- ◆ Self-closing door
- ◆ Heating element conceal in door frame to eliminate any condensation
- ◆ Complete structure interior & exterior in stainless steel AISI 304 with round internal edges for easy cleaning
- ◆ Shelf and shelf support are designed to accommodate 1 number of GN 1/1 in pan size

Options

- ◆ Casters

Technical Specifications

Model	Ext. Dimension WxDxH (mm)	Int. Dimension WxDxH (mm)	Capacity (L)	Temperature (°C)	Shelf	Power Supply
U-GN2100TN	1360×700×650	795×580×340	214	-2 ~ +8°C	2 pcs	230V/50Hz
U-GN3100TN	1795×700×650	1230×580×340	317	-2 ~ +8°C	3 pcs	230V/50Hz
U-GN4100TN	2230×700×650	1665×580×340	420	-2 ~ +8°C	4 pcs	230V/50Hz
U-GN2140TN	1360×700×650	795×580×340	214	-2 ~ +8°C	-	230V/50Hz
U-GN3160TN	1795×700×650	1230×580×340	317	-2 ~ +8°C	-	230V/50Hz
U-GN4180TN	2230×700×650	1665×580×340	420	-2 ~ +8°C	-	230V/50Hz
U-GN2100TN-2D	1360×700×650	795×580×340	214	-2 ~ +8°C	-	230V/50Hz
U-GN3100TN-3D	1795×700×650	1230×580×340	317	-2 ~ +8°C	-	230V/50Hz
U-GN4100TN-4D	2230×700×650	1665×580×340	420	-2 ~ +8°C	-	230V/50Hz

Specifications are subject to change without prior notice due to continuous product development





U-GN2X2/1



U-GN2X2/1-4D



U-GN3X2/1



U-GN3X2/1-6D

Features

- ◆ HC free refrigerant and foam
- ◆ Electronic thermostat and digital LED temperature display for accurate control and easy reading
- ◆ Ventilated refrigeration compartment gives a better air circulation
- ◆ Auto defrosting and auto evaporation of condensation water
- ◆ Magnetic gasket can be replaced without any tools
- ◆ Insulation 60 mm thickness
- ◆ Self-closing door
- ◆ Heating element conceal in door frame to eliminate any condensation
- ◆ Complete structure interior & exterior in stainless steel AISI 304 with round internal edges for easy cleaning
- ◆ Shelf and shelf support are designed to accommodate 1 number of GN 2/1 in pan size

Options

- ◆ Casters



Technical Specifications

Model	Ext. Dimension WxDxH (mm)	Int. Dimension WxDxH (mm)	Capacity (L)	Temperature (°C)	Shelf	Power Supply
U-GN2X2/1	1770x800x640	1209x680x340	270	-2 ~ +8°C	2 pcs	230V/50Hz
U-GN3X2/1	2410x800x640	1849x680x340	420	-2 ~ +8°C	3 pcs	230V/50Hz
U-GN2X2/1-4D	1770x800x640	1209x680x340	270	-2 ~ +8°C	-	230V/50Hz
U-GN3X2/1-6D	2410x800x640	1849x680x340	420	-2 ~ +8°C	-	230V/50Hz

Specifications are subject to change without prior notice due to continuous product development





PA2100TN



PA3100TN



PA2200TN



PA3200TN

Features

- ◆ HC free refrigerant and foam
- ◆ Electronic thermostat and digital LED temperature display for accurate control and easy reading
- ◆ Ventilated refrigeration compartment gives a better air circulation
- ◆ Auto defrosting and auto evaporation of condensation water
- ◆ Magnetic gasket can be replaced without any tools
- ◆ Self-closing door
- ◆ Heating element conceal in door frame to eliminate any condensation
- ◆ Complete structure interior & exterior in stainless steel AISI 304 with round internal edges for easy cleaning
- ◆ Design for 400mmx600mm shelf

Options

- ◆ Casters
- ◆ Stainless steel shelf

Technical Specifications



Model	Ext. Dimension WxDxH (mm)	Int. Dimension WxDxH (mm)	Capacity (L)	Temperature (°C)	Shelf	Power Supply
PA2100TN	1510x800x860	945x680x560	428	-2 ~ +8°C	2 pcs	230V/50Hz
PA3100TN	2020x800x860	1455x680x560	635	-2 ~ +8°C	3 pcs	230V/50Hz
PA2200TN	1510x800x960	945x680x560	428	-2 ~ +8°C	2 pcs	230V/50Hz
PA3200TN	2020x800x960	1455x680x560	635	-2 ~ +8°C	3 pcs	230V/50Hz

Specifications are subject to change without prior notice due to continuous product development





PA1500TN



PA2000TN



PA2500TN

Features

- ◆ HC free refrigerant and foam
- ◆ Electronic thermostat and digital LED temperature display for accurate control and easy reading
- ◆ Ventilated refrigeration compartment gives a better air circulation
- ◆ Auto defrosting and auto evaporation of condensation water
- ◆ Magnetic gasket can be replaced without any tools
- ◆ Self-closing door
- ◆ Heating element conceal in door frame to eliminate any condensation
- ◆ Complete structure interior & exterior in stainless steel AISI 304 with round internal edges for easy cleaning
- ◆ Design for 400mm×600mm shelf

Technical Specifications



Model	Ext. Dimension W×D×H (mm)	Int. Dimension W×D×H (mm)	Capacity (L)	Temperature (°C)	Shelf	Power Supply
PA1500TN	1505×800×860	925×680×560	413	-2 ~ +8°C	2 pcs	230V/50Hz
PA2000TN	2005×800×860	1425×680×560	614	-2 ~ +8°C	3 pcs	230V/50Hz
PA2500TN	2505×800×860	1925×680×560	814	-2 ~ +8°C	4 pcs	230V/50Hz

Specifications are subject to change without prior notice due to continuous product development



Options

- ◆ Casters
- ◆ Stainless steel shelf
- ◆ Set drawers instead of doors
- ◆ Lamp



PA2X450



PA3X450

Features

- ◆ HC free refrigerant and foam
- ◆ Electronic thermostat and digital LED temperature display for accurate control and easy reading
- ◆ Ventilated refrigeration compartment gives a better air circulation
- ◆ Auto defrosting and auto evaporation of condensation water
- ◆ Magnetic gasket can be replaced without any tools
- ◆ Self-closing door
- ◆ Heating element concealed in door frame to eliminate any condensation
- ◆ Complete structure interior & exterior in stainless steel AISI 304 with round internal edges for easy cleaning
- ◆ Design for 450mm×600mm shelf

Options

- ◆ Casters
- ◆ Stainless steel shelf

Technical Specifications



Model	Ext. Dimension W×D×H (mm)	Int. Dimension W×D×H (mm)	Capacity (L)	Temperature (°C)	Shelf	Power Supply
PA2X450	1770×800×860	1209×680×564	450	-2 ~ +8°C	2 pcs	230V/50Hz
PA3X450	2410×800×860	1849×680×564	650	-2 ~ +8°C	3 pcs	230V/50Hz

Specifications are subject to change without prior notice due to continuous product development





GN-2100 Coldpan

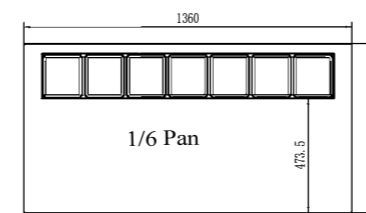

Top view of GN-2100 Coldpan



GN-3100 Coldpan

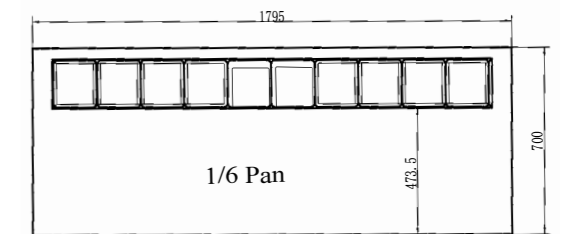

Top view of GN-3100 Coldpan

Features

- ◆ HC free refrigerant and foam
- ◆ Electronic thermostat and digital LED temperature display for accurate control and easy reading
- ◆ Auto defrosting and auto evaporation of condensation water
- ◆ Magnetic gaskets can be replaced without any tools
- ◆ Bottom with round edges for easy cleaning
- ◆ Designed to accommodate GN1/6 pans on top & GN 1/1 shelves
- ◆ Special cooling system design to keep food in right temperature
- ◆ AISI 304 stainless steel framework construction

Options

- ◆ Casters
- ◆ Stainless steel shelf

Technical Specifications

Model	Ext. Dimension WxDxH (mm)	GN Compatibility	Temperature (°C)	Shelf	Power Supply
GN-2100 Coldpan	1360x700x810	7 x GN 1/6 Pan	-2 ~ +8°C	2 pcs	230V/50Hz
GN-3100 Coldpan	1795x700x810	10 x GN 1/6 Pan	-2 ~ +8°C	3 pcs	230V/50Hz

Specifications are subject to change without prior notice due to continuous product development



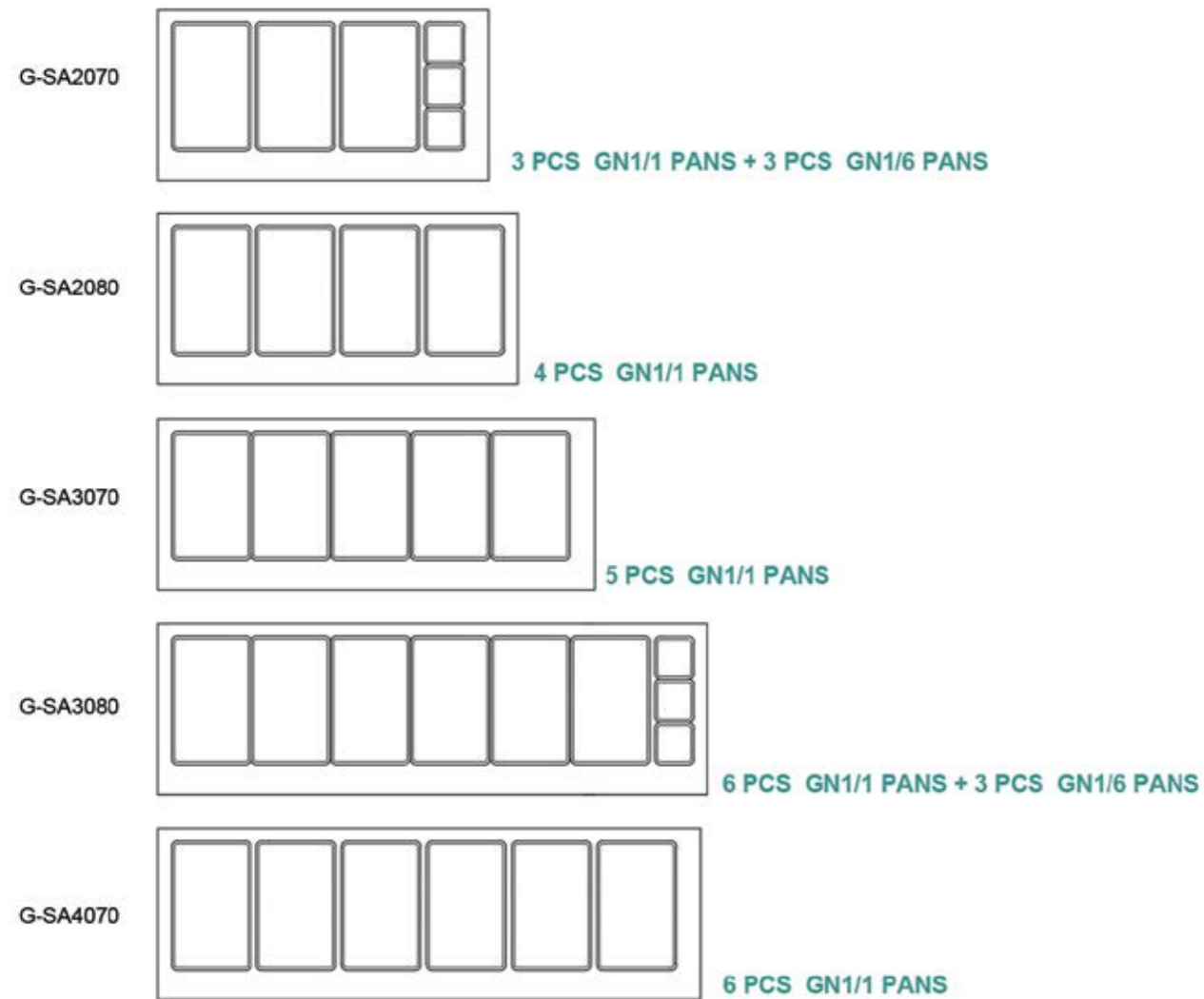

SA2070 / SA 2080



SA3070 / SA3080



SA4070

Features

- ◆ HC free refrigerant and foam
- ◆ Electronic thermostat and digital LED temperature display for accurate control and easy reading
- ◆ Auto defrosting and auto evaporation of condensation water
- ◆ Magnetic gaskets can be replaced without any tools
- ◆ Bottom with round edges for easy cleaning
- ◆ SA2070/SA3070/SA4070 designed to accommodate GN1/1 shelf SA2080/SA3080 designed to accommodate 400x600 shelf
- ◆ Special cooling system design to keep food in right temperature
- ◆ AISI 304 stainless steel framework construction

Options

- ◆ Casters
- ◆ Stainless steel shelf

Technical Specifications

Model	Ext. Dimension WxDxH (mm)	Int. Dimension WxDxH (mm)	Capacity (L)	Temperature (°C)	Shelf	Power Supply
SA2070	1360x700x1365	795x580x560	314	-2 ~ +8°C	2 pcs	230V/50Hz
SA2080	1510x800x1365	945x680x560	428	-2 ~ +8°C	2 pcs	230V/50Hz
SA3070	1795x700x1365	1230x580x560	456	-2 ~ +8°C	3 pcs	230V/50Hz
SA3080	2020x800x1365	1455x680x560	635	-2 ~ +8°C	3 pcs	230V/50Hz
SA4070	2230x700x1365	1665x580x560	616	-2 ~ +8°C	4 pcs	230V/50Hz

Specifications are subject to change without prior notice due to continuous product development



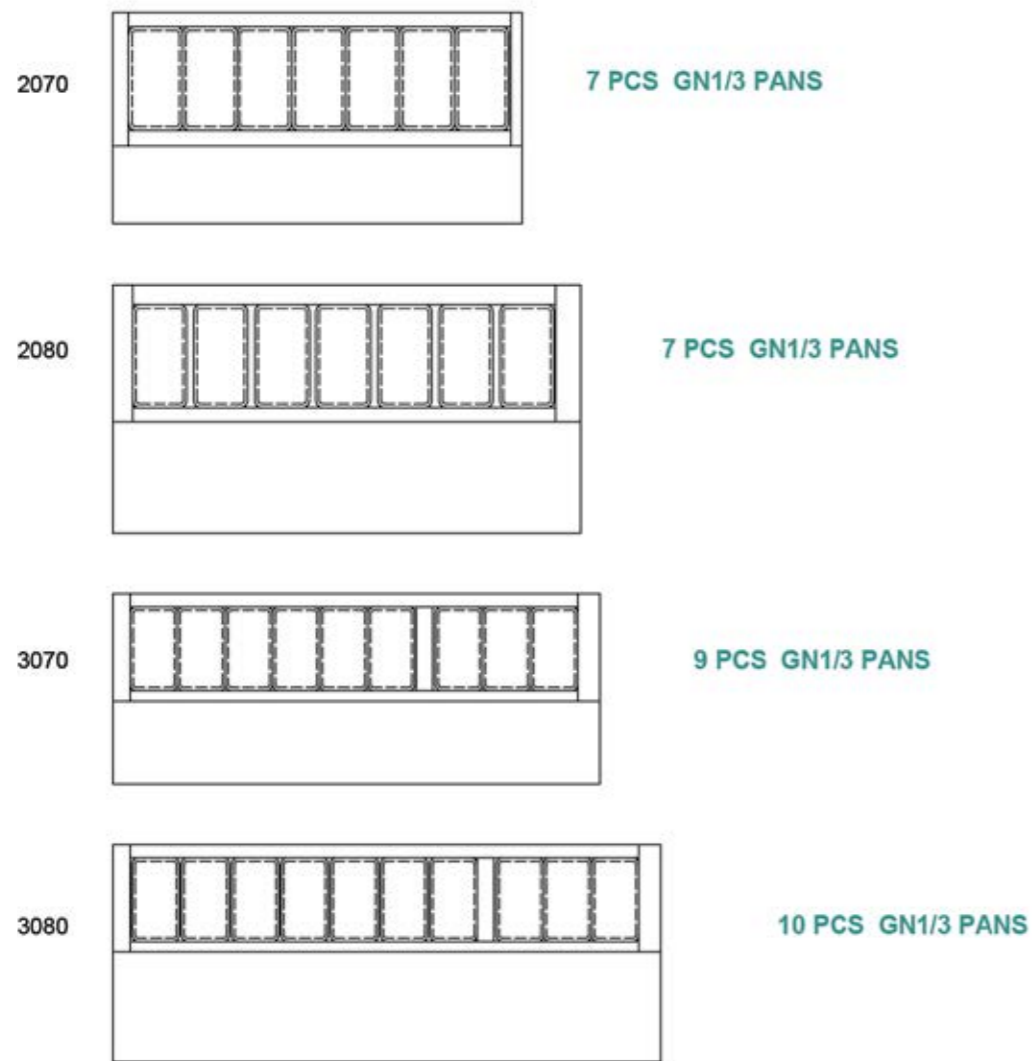

SH2070 / SH2080



SH3070 / SH3080



SH2070 / SH2080



SH3070 / SH3080

Features

- ◆ HC free refrigerant and foam
- ◆ Electronic thermostat and digital LED temperature display for accurate control and easy reading
- ◆ Auto defrosting and auto evaporation of condensation water
- ◆ Magnetic gaskets can be replaced without any tools
- ◆ Bottom with round edges for easy cleaning
- ◆ SH2070/SH3070 designed to accommodate GN1/1 shelf SH2080/SH3080 designed to accommodate 400x600 shelf
- ◆ With insulation top lid
- ◆ Special cooling system design to keep food in right temperature
- ◆ AISI 304 stainless steel framework construction

Options

- ◆ Plastic cutting board depth 450mm

Technical Specifications

Model	Ext. Dimension WxDxH (mm)	Int. Dimension WxDxH (mm)	Capacity (L)	GN1/3 PANS	Temperature (°C)	Shelf	Power Supply
SH2070	1360x700x1085	795x580x560	396	7	-2 ~ +8°C	2 pcs	230V/50Hz
SH2080	1510x800x1085	945x680x560	459	7	-2 ~ +8°C	2 pcs	230V/50Hz
SH3070	1795x700x1085	1230x580x560	576	9	-2 ~ +8°C	3 pcs	230V/50Hz
SH3080	2020x800x1085	1455x680x560	670	10	-2 ~ +8°C	3 pcs	230V/50Hz

Specifications are subject to change without prior notice due to continuous product development





SH2080MT



SH3080MT



SH4080MT

Features

- ◆ Marble top
- ◆ HC free refrigerant and foam
- ◆ Electronic thermostat and digital LED temperature display for accurate control and easy reading
- ◆ Auto defrosting and auto evaporation of condensation water
- ◆ Magnetic gaskets can be replaced without any tools
- ◆ AISI 304 stainless steel framework construction
- ◆ Bottom with round edges for easy cleaning

Technical Specifications



Model	Ext. Dimension WxDxH (mm)	Int. Dimension WxDxH (mm)	Capacity (L)	Temperature (°C)	Shelf	Power Supply
SH2080MT	1505x850x1050	925x680x560	496	-2 ~ +8°C	2 pcs	230V/50Hz
SH3080MT	2005x850x1050	1425x680x560	725	-2 ~ +8°C	3 pcs	230V/50Hz
SH4080MT	2505x850x1050	1925x680x560	943	-2 ~ +8°C	4 pcs	230V/50Hz

Specifications are subject to change without prior notice due to continuous product development





PZ2600TN



PZ3600TN



PZ1610TN



PZ2610TN



Features

- ◆ Marble top
- ◆ HC free refrigerant and foam
- ◆ Electronic thermostat and digital LED temperature display for accurate control and easy reading
- ◆ Auto defrosting and auto evaporation of condensation water
- ◆ Magnetic gaskets can be replaced without any tools
- ◆ AISI 304 stainless steel framework construction
- ◆ Bottom with round edges for easy cleaning

Options

- ◆ Casters
- ◆ Stainless steel shelf
- ◆ Set drawers instead of doors
- ◆ Different colour marble

Technical Specifications

Model	Ext. Dimension WxDxH (mm)	Int. Dimension WxDxH (mm)	Capacity (L)	Temperature (°C)	Shelf	Power Supply
PZ1610TN	1515×800×1000	435×680×560	221	-2 ~ +8°C	-	230V/50Hz
PZ2600TN	1510×800×1000	945×680×560	428	-2 ~ +8°C	-	230V/50Hz
PZ2610TN	2025×800×1000	945×680×560	428	-2 ~ +8°C	-	230V/50Hz
PZ3600TN	2020×800×1000	1455×680×560	635	-2 ~ +8°C	-	230V/50Hz

Specifications are subject to change without prior notice due to continuous product development



Compressor at the bottom



PZ4001



PZ9001



PZ9031

Features

- ◆ Marble top
- ◆ HC free refrigerant and foam
- ◆ Electronic thermostat and digital LED temperature display for accurate control and easy reading
- ◆ Auto defrosting and auto evaporation of condensation water
- ◆ Magnetic gaskets can be replaced without any tools
- ◆ AISI 304 stainless steel framework construction
- ◆ Bottom with round edges for easy cleaning

Options

- ◆ Casters
- ◆ Stainless steel shelf
- ◆ Set drawers instead of doors
- ◆ Different colour marble

Technical Specifications



Model	Ext. Dimension WxDxH (mm)	Int. Dimension WxDxH (mm)	Capacity (L)	Temperature (°C)	Shelf	Power Supply
PZ4001	1000x700x1060	365x595x456	109	-2 ~ +8°C	1 pcs	230V/50Hz
PZ9001	1420x700x1060	830x595x456	257	-2 ~ +8°C	2 pcs	230V/50Hz
PZ9031	1795x700x1060	1291x595x456	400	-2 ~ +8°C	3 pcs	230V/50Hz

Specifications are subject to change without prior notice due to continuous product development



Compressor on the side



PZ1500



PZ2000



PZ2500

Features

- ◆ Marble top
- ◆ HC free refrigerant and foam
- ◆ Electronic thermostat and digital LED temperature display for accurate control and easy reading
- ◆ Auto defrosting and auto evaporation of condensation water
- ◆ Magnetic gaskets can be replaced without any tools
- ◆ AISI 304 stainless steel framework construction
- ◆ Bottom with round edges for easy cleaning

Options

- ◆ Casters
- ◆ Stainless steel shelf
- ◆ Set drawers instead of doors
- ◆ Different colour marble

Technical Specifications



Model	Ext. Dimension WxDxH (mm)	Int. Dimension WxDxH (mm)	Capacity (L)	Temperature (°C)	Shelf	Power Supply
PZ1500	1505x800x1000	925x680x560	413	+2 ~ +4C	-	230V/50Hz
PZ2000	2005x800x1000	1425x680x560	614	+2 ~ +4°C	-	230V/50Hz
PZ2500	2505x800x1000	1925x680x560	814	+2 ~ +4°C	-	230V/50Hz

Specifications are subject to change without prior notice due to continuous product development





140PT/140 NT



140PTG

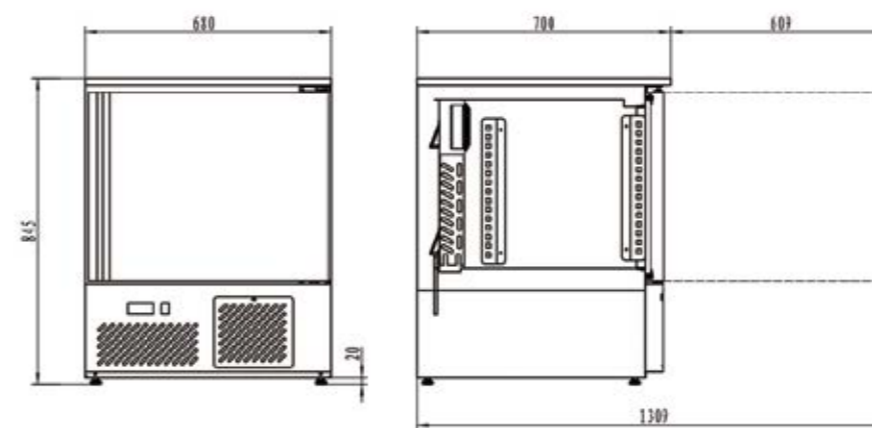

G-140PT / G-140NT/ G-140 FISH

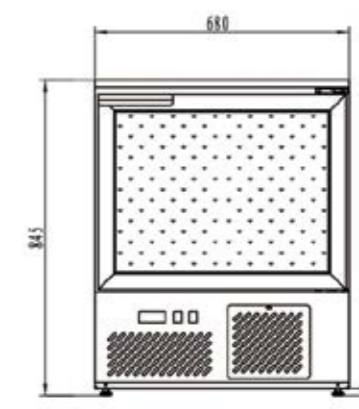

G-140PTG

Features

- ◆ HC free refrigerant and foam
- ◆ Electronic thermostat and digital LED temperature display for accurate control and easy reading
- ◆ Auto defrosting and auto evaporation of condensation water
- ◆ Magnetic gasket can be replaced without any tools
- ◆ Insulation 60 mm thickness for better energy efficiency
- ◆ Self-closing door
- ◆ Heating element conceal in door frame to eliminate any condensation
- ◆ Complete structure interior & exterior in stainless steel AISI 304 with round internal edges for easy cleaning
- ◆ Shelf and shelf support are designed to accommodate 460x530x100mm in pan size



Technical Specifications

Model	Ext. Dimension WxDxH (mm)	Int. Dimension WxDxH (mm)	Capacity (L)	Temperature (°C)	Shelf	Power Supply
140PT	680x700x845	560x500x475	150	+2 ~ +8°C	2 pc	230V/50Hz
140NT	680x700x845	560x500x475	150	-20 ~ -15°C	2 pc	230V/50Hz
140PTG	680x700x845	560x500x475	150	-2 ~ +8°C	2 pcs	230V/50Hz

Specifications are subject to change without prior notice due to continuous product development





S400



S401 / S400BT



S401-2D



S903



S903 S/S TOP

Features

- ◆ HC free refrigerant and foam
- ◆ Electronic thermostat and digital LED temperature display for accurate control and easy reading
- ◆ Auto defrosting and auto evaporation of condensation water
- ◆ Magnetic gasket can be replaced without any tools
- ◆ Bottom with round edges for easy cleaning
- ◆ AISI 304 stainless steel framework construction
- ◆ Shelf and shelf support are designed to accommodate 1 number of GN 1/1 in pan size

Options

- ◆ Casters
- ◆ Stainless steel shelf
- ◆ Set drawers instead of doors

Technical Specifications



Model	Ext. Dimension WxDxH (mm)	Int. Dimension WxDxH (mm)	Capacity (L)	Temperature (°C)	Shelf	Power Supply
S400	435x700x870	365x595x456	109	+2 ~ +8°C	1 pcs	230V/50Hz
S401	435x700x870	365x595x456	109	+2 ~ +8°C	1 pcs	230V/50Hz
S401-2D	435x700x870	365x595x456	109	+2 ~ +8°C	-	230V/50Hz
S400BT	475x700x870	365x595x465	109	-15 ~ -20°C	1 pcs	230V/50Hz
S903	1365x700x870	1295x595x456	400	+2 ~ +8°C	3 pcs	230V/50Hz
S903 S/S TOP	1368x700x870	1295x595x456	400	+2 ~ +8°C	3 pcs	230V/50Hz

Specifications are subject to change without prior notice due to continuous product development





S900



S900 ML



S902



S901 / SS45BT



S901-2D



S901-4D



Features

- ◆ HC free refrigerant and foam
- ◆ Electronic thermostat and digital LED temperature display for accurate control and easy reading
- ◆ Auto defrosting and auto evaporation of condensation water
- ◆ Magnetic gasket can be replaced without any tools
- ◆ Bottom with round edges for easy cleaning
- ◆ AISI 304 stainless steel framework construction
- ◆ Shelf and shelf support are designed to accommodate 1 number of GN 1/1 in pan size

Options

- ◆ Casters
- ◆ Stainless steel shelf
- ◆ Set drawers instead of doors

Technical Specifications



Model	Ext. Dimension WxDxH (mm)	Int. Dimension WxDxH (mm)	Capacity (L)	Temperature (°C)	Shelf	Power Supply
S900	900x700x870	830x595x456	257	+2 ~ +8°C	2 pcs	230V/50Hz
S901	903x700x870	830x595x456	257	+2 ~ +8°C	2 pcs	230V/50Hz
S901-2D	903x700x870	830x595x456	257	+2 ~ +8°C	1 pc	230V/50Hz
S901-4D	903x700x870	830x595x456	257	+2 ~ +8°C	-	230V/50Hz
S900 ML	903x700x842	830x595x550	205	+2 ~ +8°C	1 pc	230V/50Hz
SS45BT	943x700x855	830x595x411	257	-15~-20°C	2 pcs	230V/50Hz
S902	1045x700x870	975x595x456	302	+2 ~ +8°C	2 pcs	230V/50Hz

Specifications are subject to change without prior notice due to continuous product development



PS200



PS300



PS200G



PS300G

Features

- ◆ HC free refrigerant and foam
- ◆ Electronic thermostat and digital LED temperature display for accurate control and easy reading
- ◆ Auto defrosting and auto evaporation of condensation water
- ◆ Magnetic gasket can be replaced without any tools
- ◆ Bottom with round edges for easy cleaning
- ◆ AISI 304 stainless steel framework construction
- ◆ Shelf and shelf support are designed to accommodate 1 number of GN 1/1 in pan size

Options

- ◆ Casters
- ◆ Stainless steel shelf
- ◆ Set drawers instead of doors

Technical Specifications



Model	Ext. Dimension WxDxH (mm)	Int. Dimension WxDxH (mm)	Capacity (L)	Temperature (°C)	Shelf	Power Supply
S900 CG	900x700x1340	830x595x456	257	+2 ~ +8°C	2 pcs	230V/50Hz
S903 CG	1365x700x1340	1295x595x456	400	+2 ~ +8°C	3 pcs	230V/50Hz
S900 SG	900x700x1340	830x595x456	257	+2 ~ +8°C	2 pcs	230V/50Hz
S903 SG	1365x700x1340	1295x595x456	400	+2 ~ +8°C	3 pcs	230V/50Hz

Specifications are subject to change without prior notice due to continuous product development





PS200



PS300



PS200G



PS300G

Features

- ◆ HC free refrigerant and foam
- ◆ Electronic thermostat and digital LED temperature display for accurate control and easy reading
- ◆ Auto defrosting and auto evaporation of condensation water
- ◆ Magnetic gasket can be replaced without any tools
- ◆ Bottom with round edges for easy cleaning
- ◆ AISI 304 stainless steel framework construction
- ◆ Shelf and shelf support are designed to accommodate 1 number of GN 1/1 in pan size

Options

- ◆ Casters
- ◆ Stainless steel shelf
- ◆ Set drawers instead of doors

Technical Specifications

Model	Ext. Dimension WxDxH (mm)	Int. Dimension WxDxH (mm)	Capacity (L)	Temperature (°C)	Shelf	Power Supply
PS200	903x700x1006	830x595x456	257	+2 ~ +8°C	2 pcs	230V/50Hz
PS200G	903x700x1180	830x595x456	257	+2 ~ +8°C	2 pcs	230V/50Hz
PS300	1368x700x1006	1295x595x456	444	+2 ~ +8°C	3 pcs	230V/50Hz
PS300G	1368x700x1180	1295x595x456	444	+2 ~ +8°C	3 pcs	230V/50Hz

Specifications are subject to change without prior notice due to continuous product development





PS900



PS903



S903PZ



Features

- ◆ HC free refrigerant and foam
- ◆ Electronic thermostat and digital LED temperature display for accurate control and easy reading
- ◆ Auto defrosting and auto evaporation of condensation water
- ◆ Magnetic gasket can be replaced without any tools
- ◆ Bottom with round edges for easy cleaning
- ◆ AISI 304 stainless steel framework construction
- ◆ Shelf and shelf support are designed to accommodate 1 number of GN 1/1 in pan size

Options

- ◆ Casters
- ◆ Stainless steel shelf
- ◆ Set drawers instead of doors

Technical Specifications

Model	Ext. Dimension WxDxH (mm)	Int. Dimension WxDxH (mm)	Capacity (L)	Temperature (°C)	Shelf	Power Supply
PS900	903x700x1090	830x595x456	285	+2 ~ +8°C	2 pcs	230V/50Hz
PS903	1368x700x1090	1295x595x456	400	+2 ~ +8°C	3 pcs	230V/50Hz
S903PZ	1400x700x1020	1295x595x456	400	+2 ~ +8°C	3 pcs	230V/50Hz

Specifications are subject to change without prior notice due to continuous product development





CBR1-2



CBR2-2



CBR1-3



CBR2-3

CBR1-2

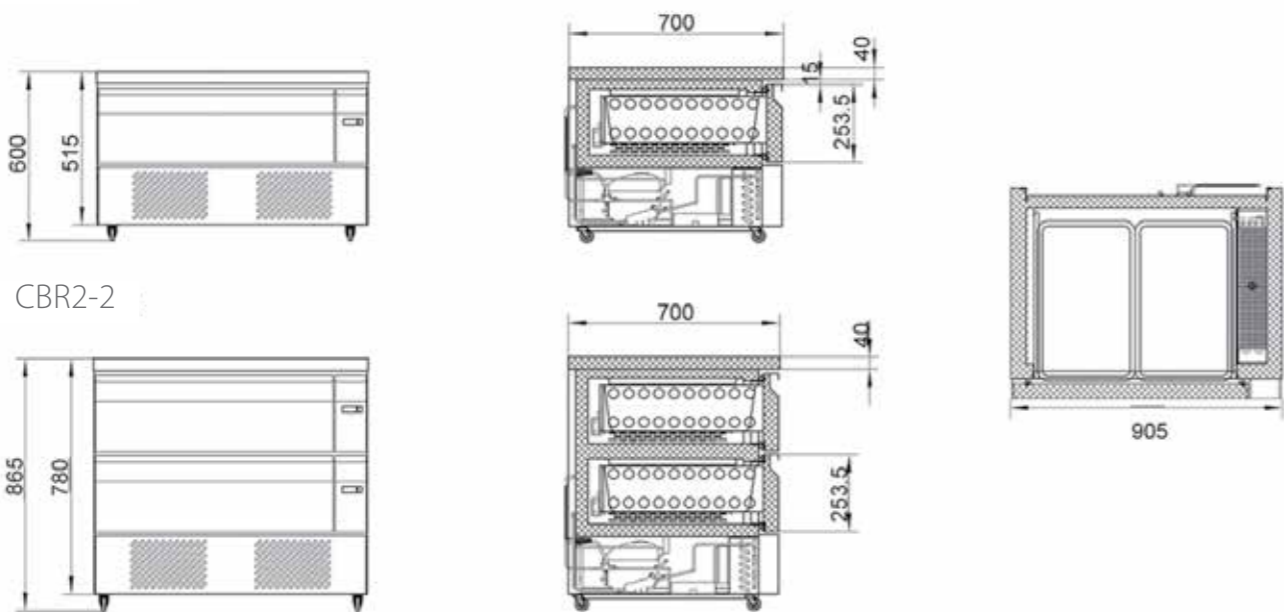

CBR1-3

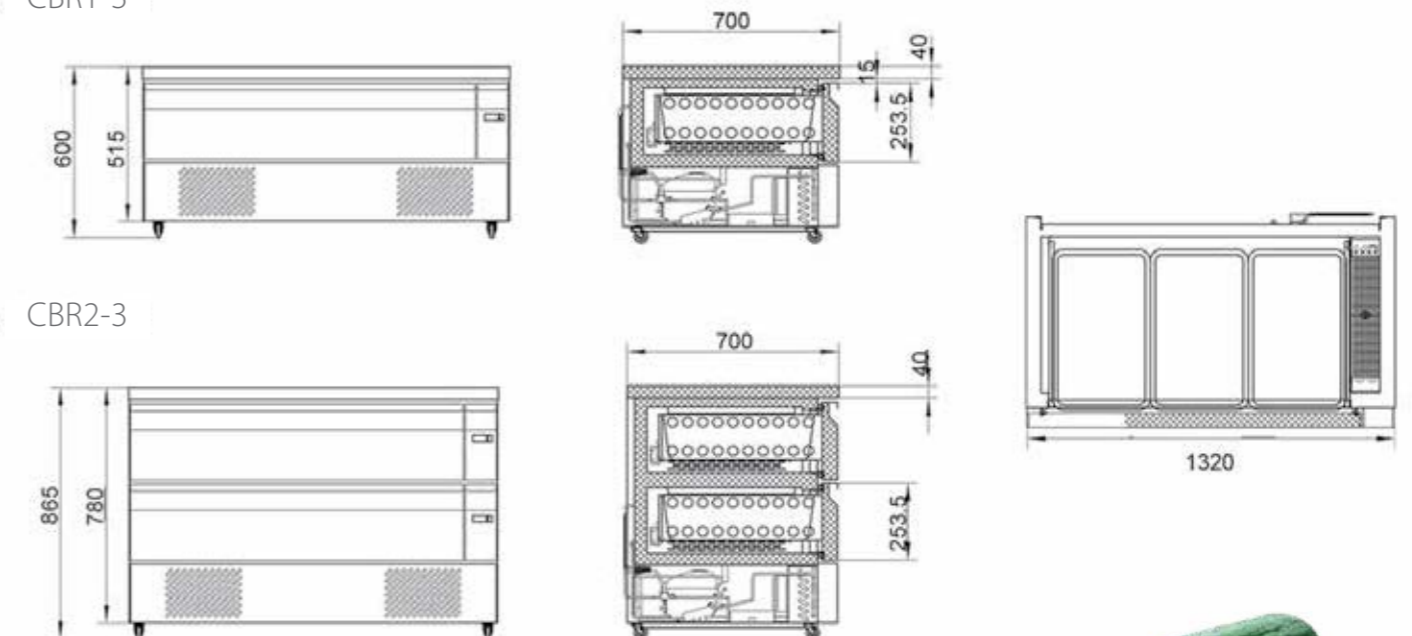

Features

- ◆ HC free refrigerant and foam
- ◆ User friendly controls with LED temperature display
- ◆ Magnetic gaskets can be replaced without any tools
- ◆ AISI 304 stainless steel framework construction
- ◆ Switch drawer temperature from chiller to freezer at the touch of a button
- ◆ GN1/1 150mm deep pan capacity maximises available storage space
- ◆ Climate Class 5(43°C ambient)
- ◆ CBR2-2/CBR2-3 with 2 cooling units

Technical Specifications



Model	Ext. Dimension WxDxH (mm)	Int. Dimension WxDxH (mm)	Capacity (L)	Temperature (°C)	GN1/1 PANS	Power Supply
CBR1-2	905×700×600	675×565×205	78	+1 ~ +4°C/-18 ~ -21°C	2 pcs	230V/50Hz
CBR2-2	905×700×865	675×565×470	179	+1 ~ +4°C/-18 ~ -21°C	4 pcs	230V/50Hz
CBR1-3	1230×700×600	1000×565×205	116	+1 ~ +4°C/-18 ~ -21°C	3 pcs	230V/50Hz
CBR2-3	1230×700×865	1000×565×470	265	+1 ~ +4°C/-18 ~ -21°C	6 pcs	230V/50Hz

Specifications are subject to change without prior notice due to continuous product development



CBR2-2R



CBR2-3R

CBR2-2R

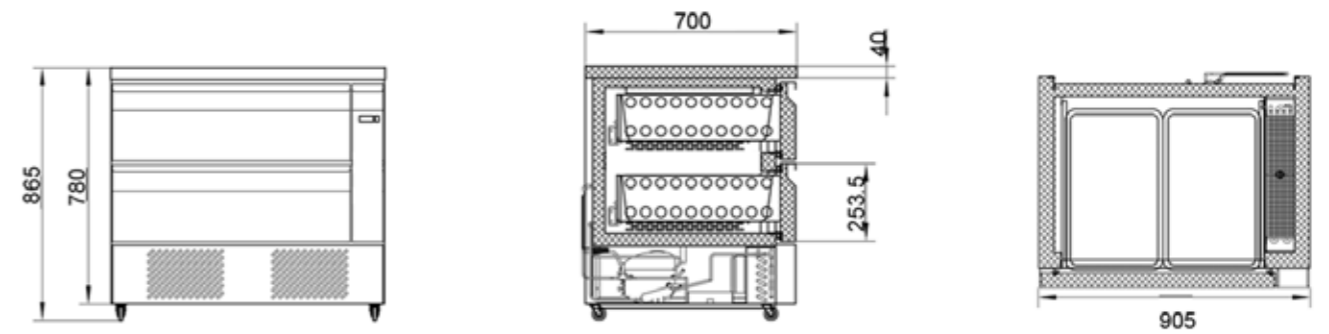

CBR2-3R

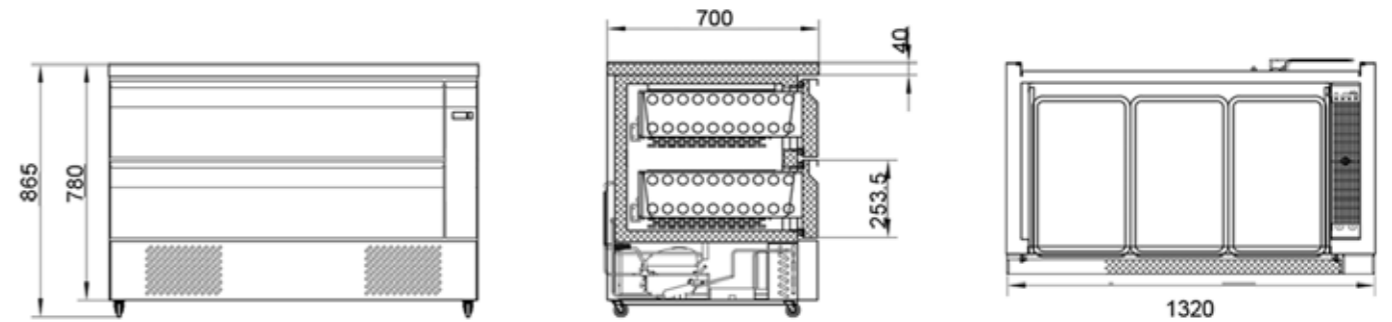

Features

- ◆ HC free refrigerant and foam
- ◆ User friendly controls with LED temperature display
- ◆ Magnetic gaskets can be replaced without any tools
- ◆ AISI 304 stainless steel framework construction
- ◆ Switch drawer temperature from chiller to freezer at the touch of a button
- ◆ GN1/1 150mm deep pan capacity maximises available storage space
- ◆ Climate Class 5(43°C ambient)
- ◆ CBR2-2/CBR2-3 with 2 cooling units

Technical Specifications

Model	Ext. Dimension WxDxH (mm)	Int. Dimension WxDxH (mm)	Capacity (L)	Temperature (°C)	GN1/1 PANS	Power Supply
CBR2-2R	905x700x865	675x565x470	179	+1 ~ +4°C	4 pcs	230V/50Hz
CBR2-3R	1230x700x865	1000x565x470	265	+1 ~ +4°C	6 pcs	230V/50Hz

Specifications are subject to change without prior notice due to continuous product development





G-SNACK2100TNG



G-SNACK3100TNG



G-SNACK4100TNG



G-SNACK2200TNG



G-SNACK3200TNG



G-SNACK4200TNG



Features

- ◆ HC free refrigerant and foam
- ◆ Electronic thermostat and digital LED temperature display for accurate control and easy reading
- ◆ Auto defrosting and auto evaporation of condensation water
- ◆ Magnetic gaskets can be replaced without any tools
- ◆ AISI 304 stainless steel framework construction
- ◆ Bottom with round edges for easy cleaning

Options

- ◆ Casters
- ◆ Set drawers instead of doors
- ◆ Stainless steel shelf
- ◆ Different colour marble top

Technical Specifications



Model	Ext. Dimension WxDxH (mm)	Int. Dimension WxDxH (mm)	Capacity (L)	Temperature (°C)	Shelf	Power Supply	Cooling mode
G-SNACK2100TNG	1360x600x860	795x480x560	260	+2 ~ +8°C	2 pcs	230V/50Hz	Ventilated
G-SNACK2200TNG	1360x600x960	795x480x560	260	+2 ~ +8°C	2 pcs	230V/50Hz	Ventilated
G-SNACK3100TNG	1795x600x860	1230x480x560	386	+2 ~ +8°C	3 pcs	230V/50Hz	Ventilated
G-SNACK3200TNG	1795x600x960	1230x480x560	386	+2 ~ +8°C	3 pcs	230V/50Hz	Ventilated
G-SNACK4100TNG	2230x600x860	1665x480x560	511	+2 ~ +8°C	4 pcs	230V/50Hz	Ventilated
G-SNACK4200TNG	2230x600x960	1665x480x560	511	+2 ~ +8°C	4 pcs	230V/50Hz	Ventilated

Specifications are subject to change without prior notice due to continuous product development



ST3
(2 CYCLES ONLY)



SD3



SD5



SD10



SD14

Features

- ◆ HC refrigerant and foam
- ◆ Ventilated refrigeration compartment.
- ◆ Touch Screen for easy operation and reading.
- ◆ 75mm thickness insulation for excellent thermal efficiency.
- ◆ Self closing doors with easy to clean and replace magnetic balloon gasket.
- ◆ Complete structure interior & exterior in stainless steel AISI 304 with round internal edges for easy cleaning
- ◆ Choice of Models from 3 sets of GN 1/1 or EN (400X600)mm to 14 sets of GN 1/1 or EN (400X600)mm
- ◆ Special insert probe feels the temperature in the heart of the product.
- ◆ Electric door mullion heater replaceable.
- ◆ Danfoss refrigeration components.
- ◆ Aspera or Danfoss compressor.
- ◆ EBM fan
- ◆ Customer friendly touch screen controller easy for reading and operating

Easy To Use



Blast Chillers +70°C to +3°C

The Blast Chilling cycle, the product temperature drops from +70°C to +3°C in 90 minutes. The transition between +65°C and +10°C (ideal climate for the proliferation of bacterial), so fast as to prevent any generation.

The Foodstuff can be kept for 8 days in normally chiller.



Shock Freezers +70°C to -18°C

The maximum storage is achieved through the rapid production of cold to allow the production of microcrystals that optimally preserve the cells of the foodstuff. The Shock Freezing drops the temperature from +70°C to -18°C in a maximum time of 240 minutes.

The food is quickly frozen and then be kept for months in normally freezer.



1 CY1: HARD CHILL+SOFT CHILL+HOLDING

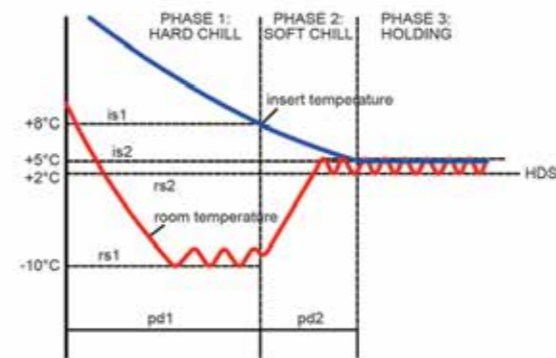

3 CY3: FREEZING CYCLE+HOLDING

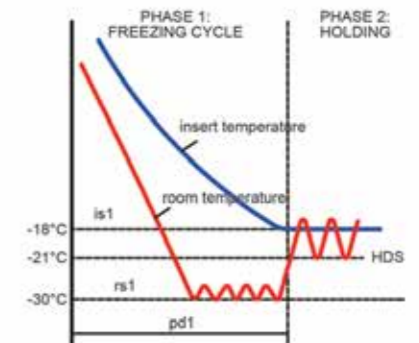

2 CY2: HARD CHILL+SOFT CHILL+FREEZING CYCLE+HOLDING

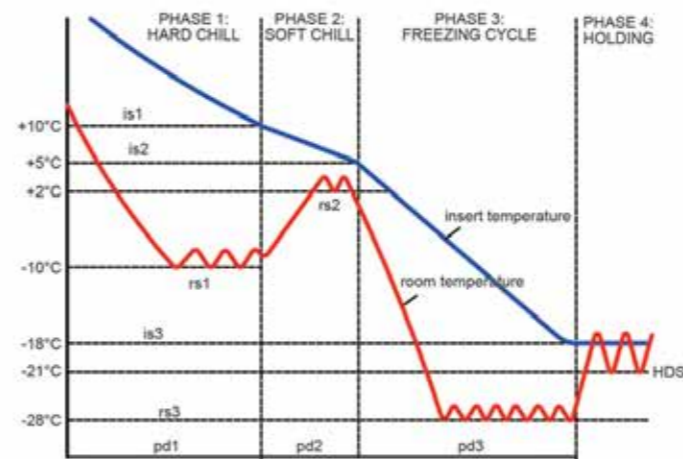

4 CY4: FREEZING CYCLE THEN STOP

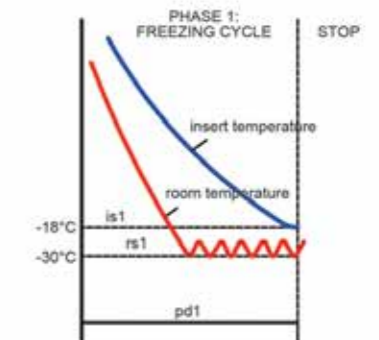

Technical Specifications

Model	Ext. Dimension WxDxH (mm)	Capacity (L)	Cooling Capability +70/3°C in 90min +70/-18°C in 240min	Shelf	Power Supply
SD3	800x815x945	139	12KG/8KG	3	230V/50Hz
SD5	800x815x1015	169	18KG/14KG	5	230V/50Hz
SD10	800x815x1645	368	40KG/28KG	10	230V/50Hz
SD14	800x815x2170	494	55KG/38KG	14	380V/50Hz
ST3	660x650x430	33	8KG/5KG	3	230V/50Hz

Specifications are subject to change without prior notice due to continuous product development





D20

LOAD CAPACITY Trolleys Not Included

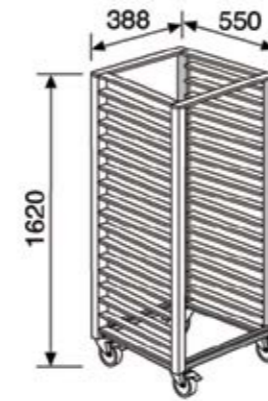

GN 1/1 TROLLEY 20 TRAYS

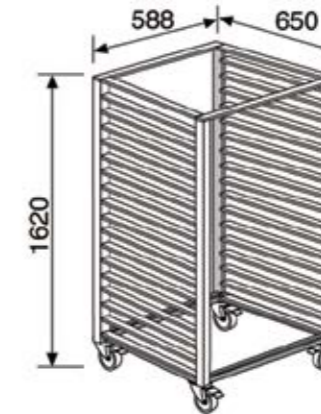

GN 2/1 TROLLEY 20 TRAYS



60x40 TROLLEY 20 TRAYS

Features

- ◆ HC refrigerant and foam
- ◆ Ventilated refrigeration compartment
- ◆ Complete structure interior & exterior in stainless steel AISI 304 with round internal edges for easy cleaning
- ◆ Self closing doors with easy to clean and replace magnetic balloon gasket.
- ◆ 100mm thickness insulation for excellent thermal efficiency.
- ◆ Special probe feels the temperature in the heart of the product.
- ◆ Electric door mullion heater replaceable.
- ◆ Customer friendly touch screen controller easy for reading and operating.

Easy To Use



Blast Chillers +70°C to +3°C

The Blast Chilling cycle, the product temperature drops from +70°C to +3°C in 90 minutes. The transition between +65°C and +10°C (ideal climate for the proliferation of bacterial), so fast as to prevent any generation.

The Foodstuff can be kept for 8 days in normally chiller.



Shock Freezers +70°C to -18°C

The maximum storage is achieved through the rapid production of cold to allow the production of microcrystals that optimally preserve the cells of the foodstuff. The Shock Freezing drops the temperature from +70°C to -18°C in a maximum time of 240 minutes.

The food is quickly frozen and then be kept for months in normally freezer.



1 CY1: HARD CHILL+SOFT CHILL+HOLDING

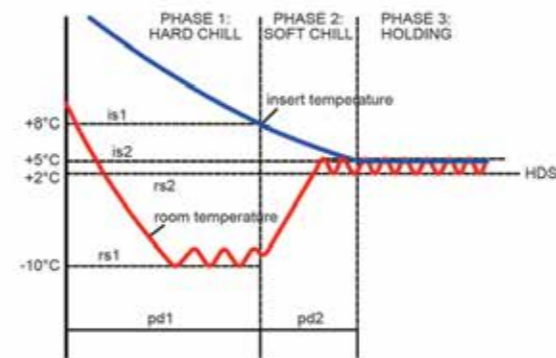

3 CY3: FREEZING CYCLE+HOLDING

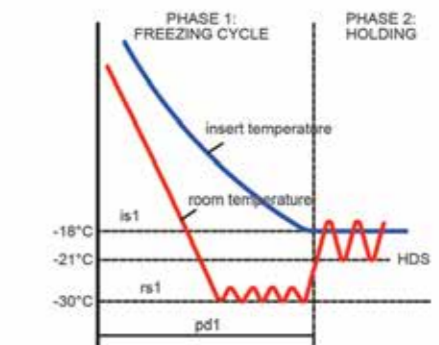

2 CY2: HARD CHILL+SOFT CHILL+FREEZING CYCLE+HOLDING

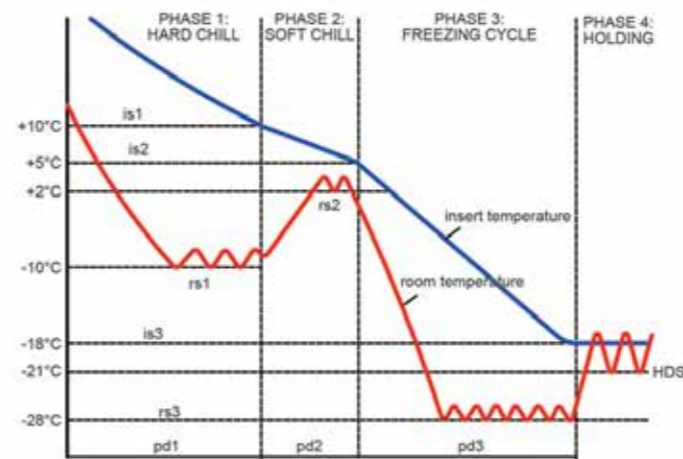

4 CY4: FREEZING CYCLE THEN STOP

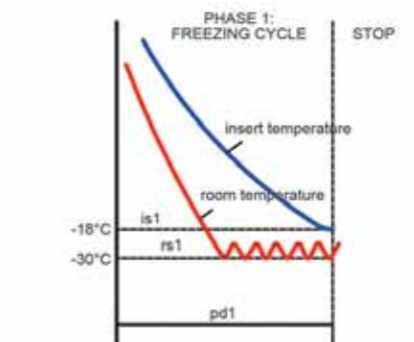

Technical Specifications



Model	Ext. Dimension WxDxH (mm)	Int. Dimension WxDxH (mm)	GN1/1 Trolleys	GN2/1 or 600x400 Trolleys	Power Supply
D20	950x1426x2180	685x890x1800	2 Pcs	1 Pc	380V/50Hz

Specifications are subject to change without prior notice due to continuous product development

Drop-in options





GN2C / GN2CF



GN3C / GN3CF



GN4C / GN4CF



GN5C



Features

- ◆ CFC free refrigerant and foam
- ◆ Electronic control with digital display
- ◆ CE certification
- ◆ RoSH compliant

Technical Specifications



Model	Ext. Dimension WxDxH (mm)	Capacity (Space of Pans)	Temperature (°C)	Cooling Mode	Power Supply
GN2C	768x678x536	2xGN1/1	+2 ~ +8°C	Static	230V/50Hz
GN3C	1102x678x536	3xGN1/1	+2 ~ +8°C	Static	230V/50Hz
GN3CF	1102x678x536	3xGN1/1	-2 ~ -10°C	Static	230V/50Hz
GN4C	1436x678x536	4xGN1/1	+2 ~ +8°C	Static	230V/50Hz
GN4CF	1436x678x536	4xGN1/1	-2 ~ -10°C	Static	230V/50Hz
GN5C	1770x678x536	5xGN1/1	+2 ~ +8°C	Static	230V/50Hz

Specifications are subject to change without prior notice due to continuous product development

Ventilated Cooling



GN2V



GN3V



GN4V



GN5V

Features

- ◆ CFC free refrigerant and foam
- ◆ Electronic control with digital display
- ◆ CE certification
- ◆ RoSH compliant

Technical Specifications



Model	Ext. Dimension WxDxH (mm)	Capacity (Space of Pans)	Temperature (°C)	Cooling Mode	Power Supply
GN2V	788x688x636	2xGN1/1	+2 ~ +8°C	Ventilated	230V/50Hz
GN3V	1122x688x636	3xGN1/1	+2 ~ +8°C	Ventilated	230V/50Hz
GN4V	1456x688x676	4xGN1/1	+2 ~ +8°C	Ventilated	230V/50Hz
GN5V	1790x688x676	5xGN1/1	+2 ~ +8°C	Ventilated	230V/50Hz

Specifications are subject to change without prior notice due to continuous product development





GN2B



GN3B



GN4B



GN5B

Features

- ◆ CFC free refrigerant and foam
- ◆ Electronic control with digital display
- ◆ CE certification
- ◆ RoSH compliant

Technical Specifications



Model	Ext. Dimension WxDxH (mm)	Capacity (Space of Pans)	Temperature (°C)	Power Supply
GN2B	768x678x536	2xGN1/1	+70~+90	230V/50Hz
GN3B	1102x678x536	3xGN1/1	+70~+90	230V/50Hz
GN4B	1436x678x536	4xGN1/1	+70~+90	230V/50Hz
GN5B	1770x678x536	5xGN1/1	+70~+90	230V/50Hz

Specifications are subject to change without prior notice due to continuous product development

Drop-in Frost Tops

The Trufrost Drop-In Frost Tops are specially designed to efficiently hold fast moving, pre-chilled food products such as grab & go menu items, trays of appetizers and cold beverages at optimum serving temperature and provide an easy, self-serve access. The display surface fits flush with the countertop to limit the effect of ambient temperature on the display area and to help maintain a pleasing, full frost view. For best performance, stainless steel pans are recommended for placement on the Frost Top.



FT-2 Marble, FT-3 Marble, FT-4 Marble



FT-2, FT-3, FT-4

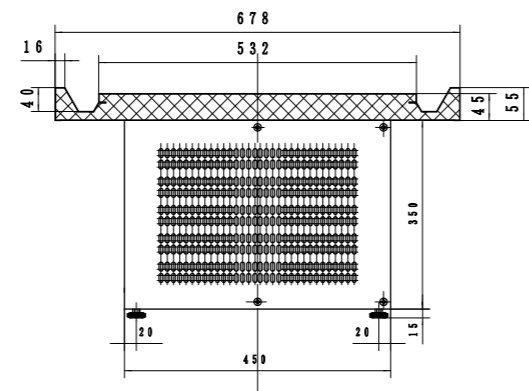
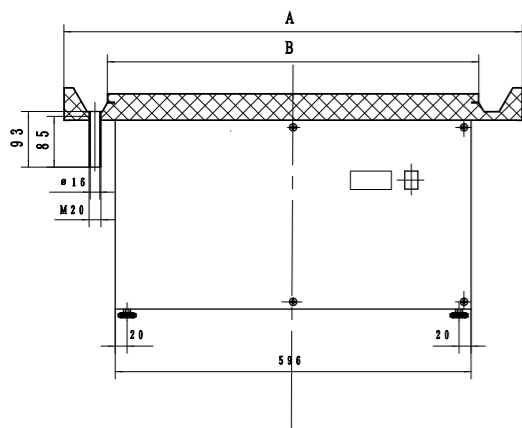

Model	A	B
FT-3	1102	956

Technical Specifications

Model	Ext. Dimension WxDxH (mm)	GN Compatibility	Power (W)	Temperature (°C)	Net Weight Kg	Power Supply
FT-2	768x678x420	2 x GN 1/1	180	+0~-10	25	230V/50Hz
FT-3	1102x678x420	3 x GN 1/1	180	+0~-10	35	230V/50Hz
FT-4	1436x678x420	4 x GN 1/1	180	+0~-10	45	230V/50Hz

Specifications are subject to change without prior notice due to continuous product development





Display Cases for Coffee & Cake Shops

Irrespective of whether you are a dedicated cake shop, patisserie or a coffee shop, the most interactive area you would have is an inviting display of confectionery and savouries. Trufrost has a whole array of stylish and contemporary confectionery showcases that would do any café & cake shop proud. For a café application, these display cases perfectly complement the Butler Coffee Machines to create a holistic customer experience.



Why Trufrost confectionery showcases are miles ahead?

Help you save on food wastage:

If the display in your showcases looks anything like the showcase shown on the top right, it is time you looked for an upgrade to Trufrost. Our display cases come with an advanced, double tempered and heated front glass that enhances visibility and prevents unhygienic condensation as would be experienced in conventional display cases. This, coupled with a reliable ventilated refrigeration system and an auto defrost ensures uniform cooling which means that your food stuff – be it the Bengali mithais or exotic cheesecakes, can stay fresh, longer.

Aesthetics:

Trufrost display cases come in an elegant combination of black glass & stainless steel and contemporary LED lighting under each shelf that enhances the display giving a very classy, premium and an international feel to the ambience.

Conventional Display



Trufrost Display



Flat Glass Showcases - Premia series

Trufrost offers a variety of showcases that are specially designed to captivate your customers. The side and front glass is clad in chic, Italian style black lacquer border and the base is specially crafted in black titanium finish stainless steel to give a premium look to your store ambience. These stunning showcases come with an advanced, double tempered and heated front glass that enhances visibility and prevents unhygienic condensation as would be experienced in conventional display cases. This, coupled with a reliable ventilated refrigeration system and an auto defrost ensures uniform cooling. They come with elegant LED lighting under each shelf for that added oomph.



CSF-44 Premia



Temptation - 44



Diva-900 Premia



Crystal Tower Premia



Frozen Tower

Technical Specifications



Model	Product	No. of Layers		Dimensions W*D*H (mm)	Volume (Litres)	Temperature Range (°C)	Front Glass	Refrigerant	Power (Watts)
		No.	Description						
CSF 44 Premia	Flat Glass 4 Layer Cake Showcase	4	Base + 3 shelves	1200*730*1300	550	2~8	Heated	R 134a	480
Temptation-44	Inclined Glass 4 Layer Cake Showcase	4	Base + 3 shelves	1200*730*1300	480	2~8	Heated	R 134a	450
Diva-900 Premia	Chocolate & Confectionery Counter with Drawers	1	Base + 2 Pullout Drawers	900*850*1125	160	2~10	Heated#	R 134a	500
Crystal Tower Premia	4 Side Glass Panoramic Cake Showcase	5	Base + 4 shelves	675*695*1800	660	2~8	Double Glass	R 290a	590
Frozen Tower	4 Side Glass 5 Layers Panoramic Ventilated Freezer Showcase	5	Base + 4 shelves	650*650*1950	319	-18 ~ -22	Double Glass	R 290a	1000

Electricals: 220V/50Hz./Single Phase

Specifications are subject to change without prior notice due to continuous product development

Top glass also heated





Countertop Displays



CTSR-23 Premia



Baby Tower

Countertop Cold Displays

Suitable for showcasing and retailing Cakes, Pastries, Indian Desserts, Dairy Products, Cold Cuts, Sandwiches and Beverages. You can choose between two models that come in a dazzling combination of steel & glass, and fitted with a reliable, bottom mounted cooling system.

Baby Tower

This newly launched stunning countertop cold display is suitable for showcasing and retailing Cakes, Pastries, Indian Desserts, Dairy Products, Cold Cuts, Sandwiches and Beverages. It comes in a dazzling combination of elegant black and glass, and is fitted with a reliable, bottom mounted cooling system.

Technical Specifications



Model	Product	No. of Layers		Dimensions W*D*H (mm)	Volume (Litres)	Temperature Range (°C)	Front Glass	Refrigerant	Power (Watts)
		No.	Description						
Baby Tower	Desk Top Tall Display Refrigerator	3	Base + 2 shelves	452*406*816	58	2~12	Double Glass	R 134a	190
CTSR-23	Countertop 3 Layer Square Glass Cake Showcase	3	Base + 2 shelves	660*530*730	68	2~8	-	R 134a	160

Electricals: 220V/50Hz./Single Phase

Specifications are subject to change without prior notice due to continuous product development

Top glass also heated

Ice cream & Gelato Scooping Displays

These stunning displays for ice cream & gelato can be used in different ways – as countertops or intelligently built-in to the counter to merge with your dessert buffet spread. You can choose between 3 models that are draped in elegant curved glass and built on a stainless steel base that houses the refrigeration system and have a digital temperature indicator. The DTF-4 comes with 4 x 5L pans. However, you have the flexibility to display more flavours of ice cream or gelato by using GN 1/6 pans (not supplied with the machine). The 2 Wow Gelato models come with with 6 x GN1/3 and 7 x GN1/3 pans respectively.



DTF-4 Premia, DTF-4 NEU



Wow Gelato - 6



Wow Gelato - 7



Wow Gelato - 12

Technical Specifications



Model	Pans		Dimensions W*D*H (mm)	Volume (Litres)	Temperature Range (°C)	Front Glass	Refrigerant	Power (Watts)
	No.	Description						
DTF-4 NEU	4	360*165*115	867*735*446	77	-18~-22	R 290	210	140
DTF-4 Premia	4	360*165*115	867*735*373	77	-18~-22	R 290	210	1400
Wow Gelato - 6	6	GN 1/3	1170*850*550	122	-13 ~ -22	-	R 404a	780
Wow Gelato - 7	7	GN 1/3	1420*680*740	142	-13 ~ -22	-	R 404a	860
Wow Gelato - 12	12	GN 1/3	1260*1045*1373	300	-13 ~ -22	Heated	R 404a	1200

Electricals: 220V/50Hz./Single Phase

Specifications are subject to change without prior notice due to continuous product development

Soft Serve Freezers

With Trufrost Soft Serve Freezers it is easy to make soft ice cream and frozen yogurt. Just add the pre-mix from your chosen dairy or premix supplier, freeze it down and in few minutes you are ready to serve. You can choose between a single flavour model and two dual flavour twin twist models – one which is a countertop freezer and the other a floor standing freezer.



Solo



Tom & Jerry Plus



2 Plus 1

Technical Specifications



Model	Flavours	Max. production	Mix Hopper capacity	Freezing cylinder capacity (Litres)	W x D x H (mm)	First Dispensing	Consecutive Dispensing#	Rated Input Power
Solo	1	10 Litres/Hr.	4 Litres x 1	1.5 x 1	220x660x660	13 minutes	4 Cups*	700 W
2 Plus 1	Twin Twist	25 Litres/Hr.	5.5 Litres x 2	1.75 x 2	540x710x1440	9 minutes	5 + 5 Cups*	2500 W
Tom & Jerry Plus	Twin Twist	22 Litres/Hr.	4.3 Litres x 2	1.6 x 2	540x850x800	10 minutes	3 + 3 Cups*	2200 W

Data based on ambient temperature of 32°C

Electricals: 220V/50Hz/1 Phase

Specifications are subject to change without prior notice due to continuous product development

Consecutive dispensing intervals assumed at 8 seconds based on practical experience

* 80 gms of dispensing taken for each cup

Countertop Sushi Display

Apart from being a point of attraction on the sushi counter, a Trufrost Sushi Showcase ensures the freshness of foodstuff. Designed with an elegant curved glass, its powerful cooling performance coupled with stable humidity & temperature control keeps sushi fresh and keeps it from drying out. It comes loaded with 5 GN ¼ pans.



CTSS-5



Technical Specifications



Prodct	Model	Dimensions (WxDxH) mm	Volume (L)	Cooling System	Refrigerant	Input Power (W)	Temperature Range (°C)	Net Weight (Kg)
Countertop Sushi Display	CTSS-5	1200*335*430	52	Static	R134a	135	+2 ~ +10	60

Electricals: 220V/50Hz/1 Phase

Specifications are subject to change without prior notice due to continuous product development

Countertop Cold Displays

Trufrost Countertop Cold Display is a versatile appliance. Apart from salads, starters and toppings, it is also ideal for storing a variety of Indian Desserts like kheer, rabadi, rasogullas, ras-malai and phirni on one hand to pani-poori, jal jeera on the other. They accept 5 GN 1/4 pans (not included) and come with a glass sneeze-guard.



VRX-1200/330



Technical Specifications



Model	Ext. Dimension WxDxH (mm)	Capacity (L)	Temperature (°C)	Power Supply
VRX 1200 (Glass)	1200x335x435	115	+2 ~ +10	230V/50Hz

Specifications are subject to change without prior notice due to continuous product development

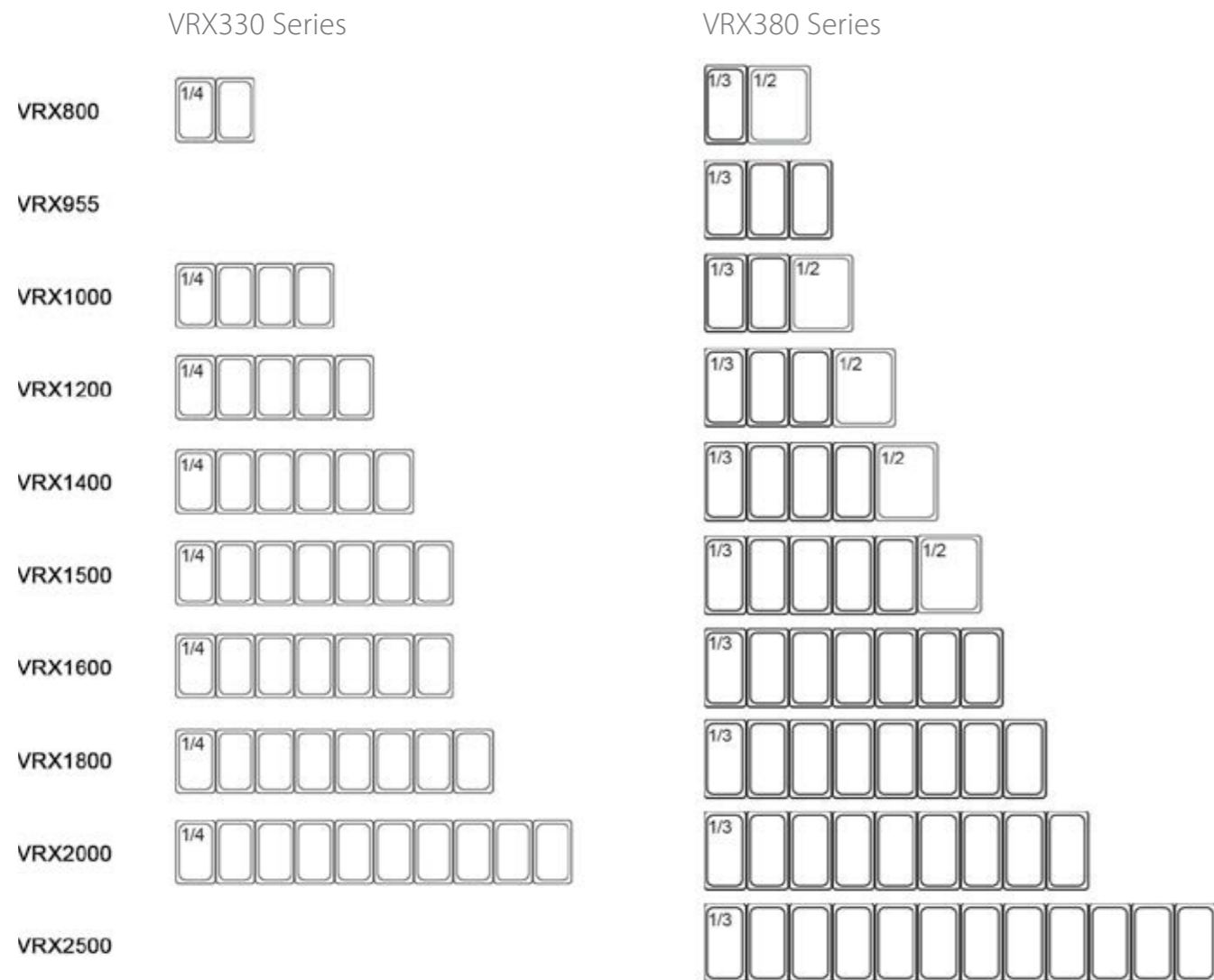

Features

- ◆ HC free refrigerant and foam
- ◆ Electronic thermostat and digital LED temperature display for accurate control and easy reading
- ◆ Replaceable flat glass cover, stainless steel cover and curved glass cover
- ◆ Complete structure AISI 304
- ◆ Static cooling with continuous evaporator without welding

Options

- ◆ Left unit
- ◆ Other Size on request

Technical Specifications



Model	Ext. Dimension WxDxH (mm)	Int. Dimension WxDxH (mm)	Capacity (space Of pans)	Temperature (°C)	Power Supply
VRX800/330	800×335×435	445×245×155	GN1/4×2	+2 ~ +8°C	230V/50Hz
VRX800/380	800×395×435	445×305×155	GN1/3×1+GN1/2×1	+2 ~ +8°C	230V/50Hz
VRX955/380	955×395×435	600×305×155	GN1/3×3	+2 ~ +8°C	230V/50Hz
VRX1000/330	1000×335×435	645×245×155	GN1/4×4	+2 ~ +8°C	230V/50Hz
VRX1000/380	1000×395×435	645×305×155	GN1/3×2+GN1/2×1	+2 ~ +8°C	230V/50Hz
VRX1200/330	1200×335×435	845×245×155	GN1/4×5	+2 ~ +8°C	230V/50Hz
VRX1200/380	1200×395×435	845×305×155	GN1/3×3+GN1/2×1	+2 ~ +8°C	230V/50Hz
VRX1400/330	1400×335×435	1045×245×155	GN1/4×6	+2 ~ +8°C	230V/50Hz
VRX1400/380	1400×395×435	1045×305×155	GN1/3×4+GN1/2×1	+2 ~ +8°C	230V/50Hz
VRX1500/330	1500×335×435	1145×245×155	GN1/4×7	+2 ~ +8°C	230V/50Hz
VRX1500/380	1500×395×435	1145×305×155	GN1/3×5+GN1/2×1	+2 ~ +8°C	230V/50Hz
VRX1600/330	1600×335×435	1245×245×155	GN1/4×7	+2 ~ +8°C	230V/50Hz
VRX1600/380	1600×395×435	1245×305×155	GN1/3×7	+2 ~ +8°C	230V/50Hz
VRX1800/330	1800×335×435	1445×245×155	GN1/4×8	+2 ~ +8°C	230V/50Hz
VRX1800/380	1800×395×435	1445×305×155	GN1/3×8	+2 ~ +8°C	230V/50Hz
VRX2000/330	2000×335×435	1645×245×155	GN1/4×10	+2 ~ +8°C	230V/50Hz
VRX2000/380	2000×395×435	1645×305×155	GN1/3×9	+2 ~ +8°C	230V/50Hz
VRX2500/380	2500×395×435	2145×305×155	GN1/3×12	+2 ~ +8°C	230V/50Hz

Specifications are subject to change without prior notice due to continuous product development

TS1200



TS1500



TS1800



TS2000



Features



◆ LED lamp



◆ Safty curved glass

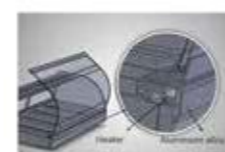

◆ Heated front glass



◆ Glass can be open and remove by hand easy for cleaning

◆ HC refrigerant

Technical Specifications



Model	Ext. Dimension WxDxH (mm)	Cooling Mode	Temperature (°C)	Power Supply
TS1200	1200x415x300	Static	+4 ~ +8°C	230V/50Hz
TS1500	1500x415x300	Static	+4 ~ +8°C	230V/50Hz
TS1800	1800x415x300	Static	+4 ~ +8°C	230V/50Hz
TS2000	2000x415x300	Static	+4 ~ +8°C	230V/50Hz

Specifications are subject to change without prior notice due to continuous product development

* 1"height GN1/3 Pans included

Bottle & Beverage Coolers





B1500



B2000



B2500



Features

- ◆ HC free refrigerant and foam
- ◆ Forced-air cooling
- ◆ Adjustable dividers included
- ◆ Self-Defrosting Evaporator
- ◆ Bottle cap opener & cap catcher standard

Technical Specifications



Model	Ext. Dimension WxDxH (mm)	Int. Dimension WxDxH (mm)	Capacity (L)	Temperature (°C)	Cooling mode	Power Supply
B1500	1505x565x910	1400x470x690	440	+2 ~ +8°C	Static	230V/50Hz
B2000	2005x565x910	1900x470x690	615	+2 ~ +8°C	Static	230V/50Hz
B2500	2505x565x910	2400x470x690	790	+2 ~ +8°C	Static	230V/50Hz

Specifications are subject to change without prior notice due to continuous product development

Hinged Door



SC150G
SC148G

SC250G
SC248G

SC315G
SC316G

Sliding Door



SC150SD
SC148SD

SC250SD
SC248SD

SC315SD
SC316SD

Features

- ◆ HC free refrigerant and foam
- ◆ Electric controller with digital temperature display
- ◆ Ventilated cooling system
- ◆ Auto defrosting and Auto evaporating of defrost water
- ◆ 2 shelves per door
- ◆ Airflow from down front grill in case the unit can be used against wall
- ◆ The unit can be with white/black/brown/silver colour



Technical Specifications



Model	Ext. Dimension WxDxH (mm)	Int. Dimension WxDxH (mm)	Capacity (L)	Temperature (°C)	Cooling Mode	Shelf	Power Supply
SC150G	600x535x910	535x370x765	151	+2 ~ +8°C	Ventilated	2	230V/50Hz
SC250G	920x535x910	855x370x765	254	+2 ~ +8°C	Ventilated	4	230V/50Hz
SC315G	1350x535x910	1285x370x765	382	+2 ~ +8°C	Ventilated	6	230V/50Hz
SC148G	600x535x870	535x370x735	129	+2 ~ +8°C	Ventilated	2	230V/50Hz
SC248G	900x535x870	835x370x735	202	+2 ~ +8°C	Ventilated	4	230V/50Hz
SC316G	1350x535x870	1285x370x735	320	+2 ~ +8°C	Ventilated	6	230V/50Hz

Specifications are subject to change without prior notice due to continuous product development

Technical Specifications



Model	Ext. Dimension WxDxH (mm)	Int. Dimension WxDxH (mm)	Capacity (L)	Temperature (°C)	Cooling Mode	Shelf	Power Supply
SC150SD	600x535x910	535x370x765	151	+2 ~ +8°C	Ventilated	2	230V/50Hz
SC250SD	920x535x910	855x370x765	254	+2 ~ +8°C	Ventilated	4	230V/50Hz
SC315SD	1350x535x910	1285x370x765	382	+2 ~ +8°C	Ventilated	6	230V/50Hz
SC148SD	600x535x870	535x370x735	129	+2 ~ +8°C	Ventilated	2	230V/50Hz
SC248SD	900x535x870	835x370x735	202	+2 ~ +8°C	Ventilated	4	230V/50Hz
SC316SD	1350x535x870	1285x370x735	320	+2 ~ +8°C	Ventilated	6	230V/50Hz

Specifications are subject to change without prior notice due to continuous product development



BC2100



BC2100 D2



BC3100



BC3100 D6



BC4100



BC4100 D2

Features

- ◆ HC free refrigerant and foam
- ◆ Electric controller with digital temperature display
- ◆ Ventilated cooling system
- ◆ Auto defrosting and Auto evaporating of defrost water

Technical Specifications

Model	Ext. Dimension WxDxH (mm)	Int. Dimension WxDxH (mm)	Capacity (L)	Temperature (°C)	Cooling Mode	Shelf	Power Supply
BC2100	1462x513x860	1082x415x720	350	+2 ~ +8°C	Ventilated	4	230V/50Hz
BC3100	2002x513x860	1622x415x720	537	+2 ~ +8°C	Ventilated	6	230V/50Hz
BC4100	2542x513x860	2162x415x720	698	+2 ~ +8°C	Ventilated	8	230V/50Hz
BC2100 D2	1462x513x860	1082x415x720	350	+2 ~ +8°C	Ventilated	2	230V/50Hz
BC3100 D6	2002x513x860	1622x415x720	537	+2 ~ +8°C	Ventilated	-	230V/50Hz
BC4100 D2	2542x513x860	2162x415x720	698	+2 ~ +8°C	Ventilated	6	230V/50Hz

Specifications are subject to change without prior notice due to continuous product development





BC2100G



BC3100G



BC4100G



Features

- ◆ HC free refrigerant and foam
- ◆ Electric controller with digital temperature display
- ◆ Ventilated cooling system
- ◆ Auto defrosting and Auto evaporating of defrost water

Technical Specifications

Model	Ext. Dimension WxDxH (mm)	Int. Dimension WxDxH (mm)	Capacity (L)	Temperature (°C)	Cooling Mode	Shelf	Power Supply
BC2100G	1462x513x860	1082x415x720	350	+2 ~ +8°C	Ventilated	4	230V/50Hz
BC3100G	2002x513x860	1622x415x720	537	+2 ~ +8°C	Ventilated	6	230V/50Hz
BC4100G	2542x513x860	2162x415x720	698	+2 ~ +8°C	Ventilated	8	230V/50Hz

Specifications are subject to change without prior notice due to continuous product development





BC2100G SG (remote unit)



BC3100G SG (remote unit)



BC4100G SG (remote unit)



Features

- ◆ HC free refrigerant and foam
- ◆ Electric controller with digital temperature display
- ◆ Ventilated cooling system
- ◆ Auto defrosting and Auto evaporating of defrost water

Technical Specifications

Model	Ext. Dimension WxDxH (mm)	Int. Dimension WxDxH (mm)	Capacity (L)	Temperature (°C)	Cooling Mode	Shelf	Power Supply
BC2100G SG	1162x513x860	1082x415x720	350	+2 ~ +8°C	Ventilated	2	230V/50Hz
BC3100G SG	1702x513x860	1622x415x720	537	+2 ~ +8°C	Ventilated	-	230V/50Hz
BC4100G SG	2242x513x860	2162x415x720	698	+2 ~ +8°C	Ventilated	6	230V/50Hz

Specifications are subject to change without prior notice due to continuous product development



Back Bars with Remote Refrigeration



BC2100 SG



BC3100 SG



BC4100 SG

Features

- ◆ HC free refrigerant and foam
- ◆ Electric controller with digital temperature display
- ◆ Ventilated cooling system
- ◆ Auto defrosting and Auto evaporating of defrost water

Technical Specifications



Model	Ext. Dimension WxDxH (mm)	Int. Dimension WxDxH (mm)	Capacity (L)	Temperature (°C)	Cooling Mode	Shelf	Power Supply
BC2100 SG	1162x513x860	1082x415x720	350	+2 ~ +8°C	Ventilated	4	230V/50Hz
BC3100 SG	1702x513x860	1622x415x720	537	+2 ~ +8°C	Ventilated	6	230V/50Hz
BC4100 SG	2242x513x860	2162x415x720	698	+2 ~ +8°C	Ventilated	8	230V/50Hz

Specifications are subject to change without prior notice due to continuous product development



24" Back Bar Coolers (Swing Door)



BC48



BC60



BC72



BC48SS



BC60SS



BC72SS

Features

- ◆ HC free refrigerant and foam
- ◆ Electronic thermostat and digital LED temperature display for accurate control and easy reading
- ◆ Magnetic gasket can be replaced without any tools
- ◆ Self-closing door
- ◆ Stainless steel top
- ◆ INTERIOR: stainless steel, bottom S/S 304
- ◆ EXTERIOR: Option of powder-coated steel black and stainless steel

Technical Specifications



Model	Ext. Dimension WxDxH (mm)	Temperature (°C)	Power Supply
BC48	1247x620x920	+2 ~ +8°C	230V/50Hz
BC60	1551x620x920	+2 ~ +8°C	230V/50Hz
BC72	1856x620x920	+2 ~ +8°C	230V/50Hz
BC48SS	1247x620x920	+2 ~ +8°C	230V/50Hz
BC60SS	1551x620x920	+2 ~ +8°C	230V/50Hz
BC72SS	1856x620x920	+2 ~ +8°C	230V/50Hz

Specifications are subject to change without prior notice due to continuous product development



Swing Door



BC48G



BC60G



BC72G

Sliding Door



BC48SD



BC60SD

Features

- ◆ HC free refrigerant and foam
- ◆ Electronic thermostat and digital LED temperature display for accurate control and easy reading
- ◆ Magnetic gasket can be replaced without any tools
- ◆ Self-closing door
- ◆ Stainless steel top
- ◆ INTERIOR: stainless steel, bottom S/S 304
- ◆ EXTERIOR: powder-coated steel black

Technical Specifications



Model	Ext. Dimension WxDxH (mm)	Temperature (°C)	Power Supply
BC48G	1247x620x920	+2 ~ +8°C	230V/50Hz
BC60G	1551x620x920	+2 ~ +8°C	230V/50Hz
BC72G	1856x620x920	+2 ~ +8°C	230V/50Hz

Specifications are subject to change without prior notice due to continuous product development

Features

- ◆ HC free refrigerant and foam
- ◆ Electronic thermostat and digital LED temperature display for accurate control and easy reading
- ◆ Magnetic gasket can be replaced without any tools
- ◆ Self-closing door
- ◆ Stainless steel top
- ◆ INTERIOR: stainless steel, bottom S/S 304
- ◆ EXTERIOR: powder-coated steel black

Technical Specifications



Model	Ext. Dimension WxDxH (mm)	Temperature (°C)	Power Supply
BC48SD	1247x620x920	+2 ~ +8°C	230V/50Hz
BC60SD	1551x620x920	+2 ~ +8°C	230V/50Hz

Specifications are subject to change without prior notice due to continuous product development



BCBD29



BCBD48-1



BCBD48-2



BCBD60-1



BCBD60-2

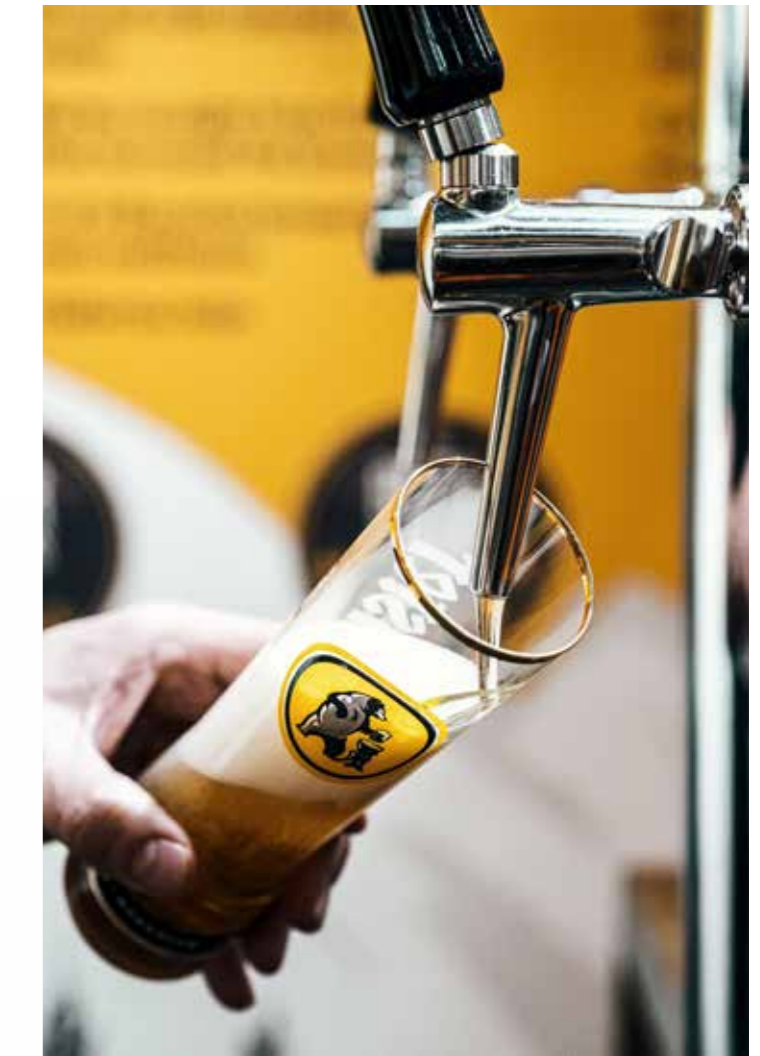

BCBD72-2

Features

- ◆ HC free refrigerant and foam
- ◆ Designed to accommodate a variety of beer kegs.
- ◆ 3" (77 mm) diameter stainless steel insulated beer column. Cold air is channeled directly into beer column to reduce foaming and maximize draft beer profits.
- ◆ INTERIOR: stainless steel, bottom S/S 304
- ◆ EXTERIOR: powder-coated steel black

Technical Specifications



Model	Ext. Dimension WxDxH (mm)	Temperature (°C)	Power Supply
BCBD29	612x759x919	+2 ~ +8°C	230V/50Hz
BCBD48-1	1247x620x919	+2 ~ +8°C	230V/50Hz
BCBD48-2	1247x620x919	+2 ~ +8°C	230V/50Hz

Specifications are subject to change without prior notice due to continuous product development

Technical Specifications



Model	Ext. Dimension WxDxH (mm)	Temperature (°C)	Power Supply
BCBD60-1	1552x620x919	+2 ~ +8°C	230V/50Hz
BCBD60-2	1552x620x919	+2 ~ +8°C	230V/50Hz
BCBD72-2	1857x620x919	+2 ~ +8°C	230V/50Hz

Specifications are subject to change without prior notice due to continuous product development

Trufrost Wine Coolers

Wines develop their full flavour when they are stored in the right conditions and served at the right temperature. Trufrost wine coolers ensure that. They create the perfect conditions for optimal storage of all types of wines – be it red, white or sparkling. You can choose among 4 different models with single, double and three temperature zone options.

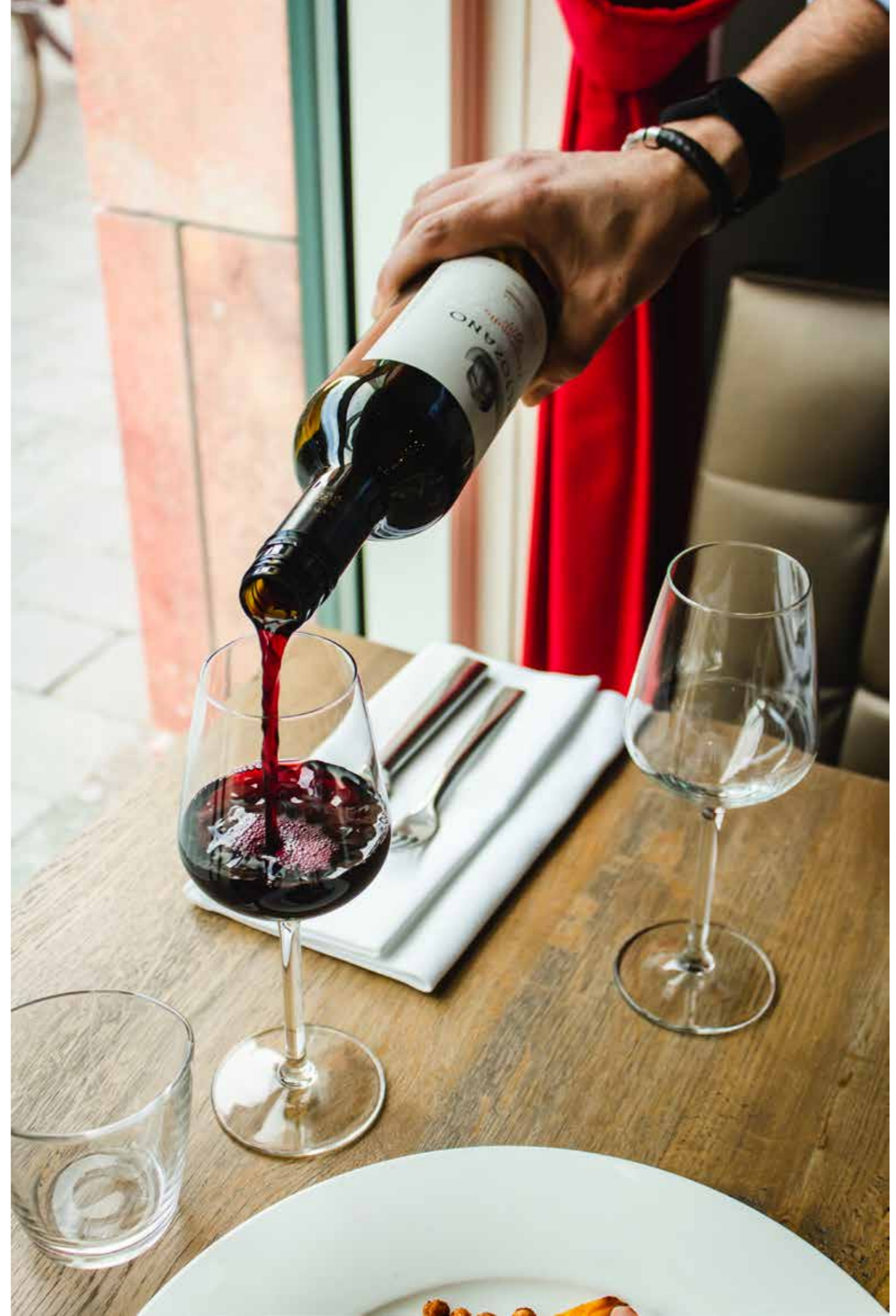

Recommended serving temperatures for different wines

Wine should always be enjoyed at the right temperature. As a general rule, red wine is best served at a temperature between 12°C and 18°C, depending on the origin, grape and year. White wine is best served between 8°C and 12°C. Champagne and fruity dessert wine should be served ice cold, between 5°C and 7°C.

White wines
8°C to 12°C

Red wines
12°C to 18°C

Sparkling wines
5°C to 7°C



Built-in



W 101 TZ

These elegant wine coolers come with 3 separate compartments for your reds, whites and champagnes and can store up to 133 bottles and 101 bottles of 0.75 litres respectively. Both models can be used as built-in or on a standalone basis. W 101 TZ also comes with changing LED lights to lend a touch of oomph to your bar.

Built-in



Eiffel Tower

Arguably the slimmest and tall wine cooler that is ideal for a large variety of wine collection with two separate compartments for your reds and whites that can store up to 54 bottles of 0.75 litres. The Eiffel Tower also comes with changing LED lights to lend a touch of oomph to your bar. It can be used as built-in or on a standalone basis.

Built-in



W 30 DZ (New)

These dual temperature zone cabinets come with two separate compartments for your reds and whites that can store up to 30 bottles of 0.75 litres - 15 bottles in each compartment. It can be used as built-in or on a standalone basis.

Standalone



W-19 SZ

These single temperature zone wine cabinets can be set at a mid-point temperature so as to cater to the storage needs of different wines and can store up to 19 and 18 bottles respectively. These are available only as a standalone wine coolers and do not have a built-in feature.

Modular Wine Walls

Trufrost Wine Coolers have a unique 'built-in' feature and allow one unit to be placed next to the other to create a modular, expandable wine wall. This eclectic arrangement can transform your wine collection into a beautiful and stunning focal point. Each of these wine coolers also come with segregated temperature zones for optimally storing your red, white and sparkling wines.



Technical Specifications - Wine Coolers



Specification	W 101 TZ	Eiffel Tower	W 30 DZ (New)	W 19 DZ
Bottle Storage (0.75 ltr)	Upper Zone: 33 Middle Zone: 33 Lower Zone: 35	Upper Zone: 27 Lower Zone: 27	Upper Zone: 15 Lower Zone: 15	19
Storage Volume (litres)	308	93	93	65
Dimensions (w*d*h) (mm)	595*575*1820	595*397*1820	380*600*880	495*450*670
Temperature Range	Upper Zone 5-15°C Middle Zone 5-15°C Lower Zone 7-18°C	Upper Zone 5-15°C Lower Zone 7-18°C	Upper Zone 5-15°C Lower Zone 7-18°C	5-20°C
Temperature Zones	Three	Dual	Dual	Single
Power (w)	200w	190w	190w	-
Digital Temperature Indicator	Yes	Yes	Yes	Yes
Lock	Yes	Yes	Yes	Yes
Glass Door	2 layered tempered brown	2 layered tempered brown	2 layered tempered brown	2 layered tempered brown
Door Handle	Steel	Steel	Steel	Steel
No. of beech wood shelves	Sliding x 9 + Display x 1	Sliding x 6	Sliding x 6	Sliding x 5
Refrigerant	R 600a	R 600a	R 600a	R 600a
Cabinet Case & Interior	Black	Black	Black	Black
Lighting under each shelf	Blue LED	Blue LED	Blue LED	Blue LED

Electricals: 220V/50Hz/1 Phase

Specifications are subject to change without prior notice due to continuous product development



Customized Wine Walls

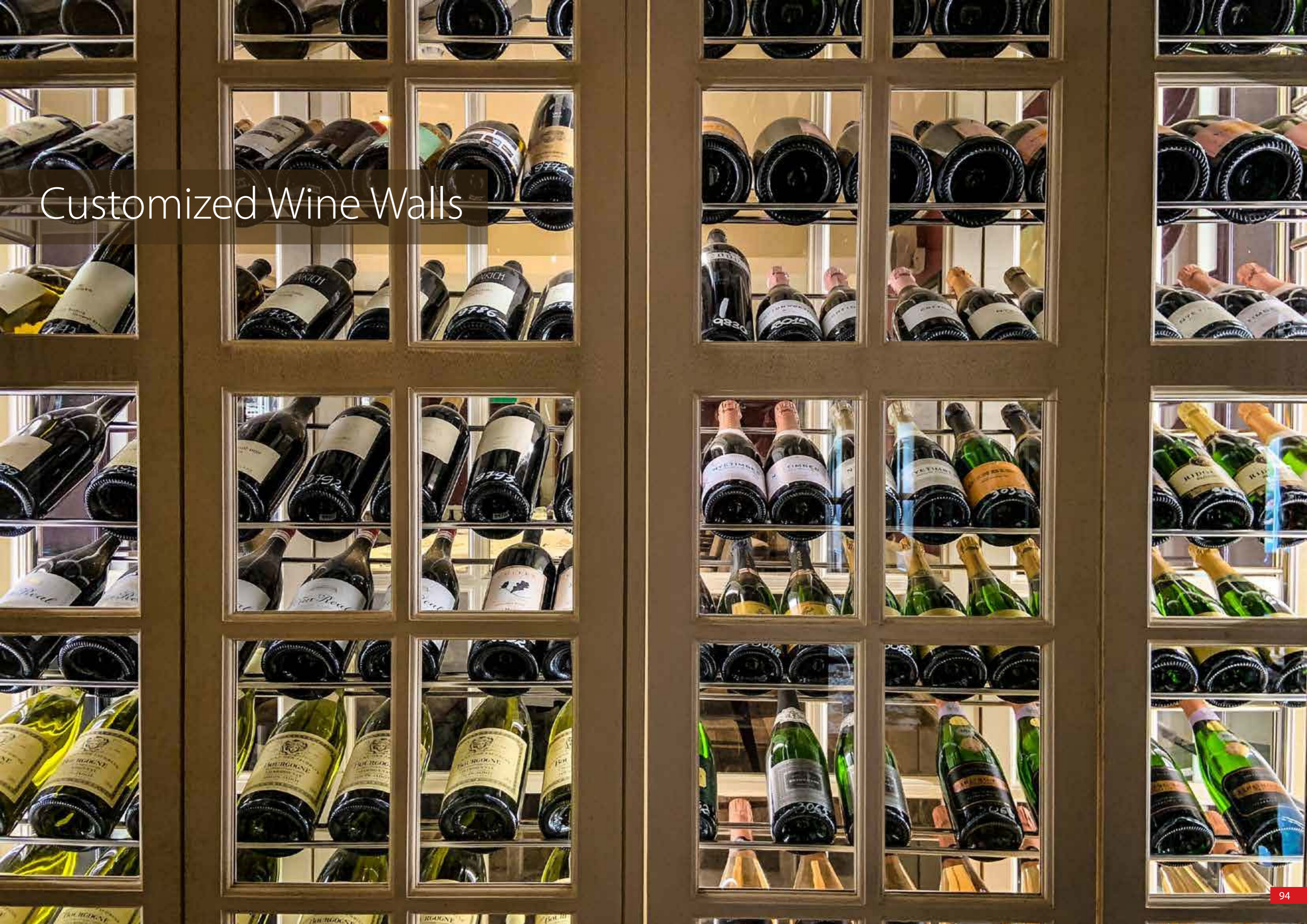

Customized Wine Walls

Trufrost customised wine walls provide a conditioned area for a surprisingly large number of bottles – without encroaching greatly on your floor space. They add impact and drama to your bar whilst protecting and showcasing your vintage collection. They are usually fitted with glass doors, combined with internal reflective finishes, backlighting and spotlighting to highlight the wines.

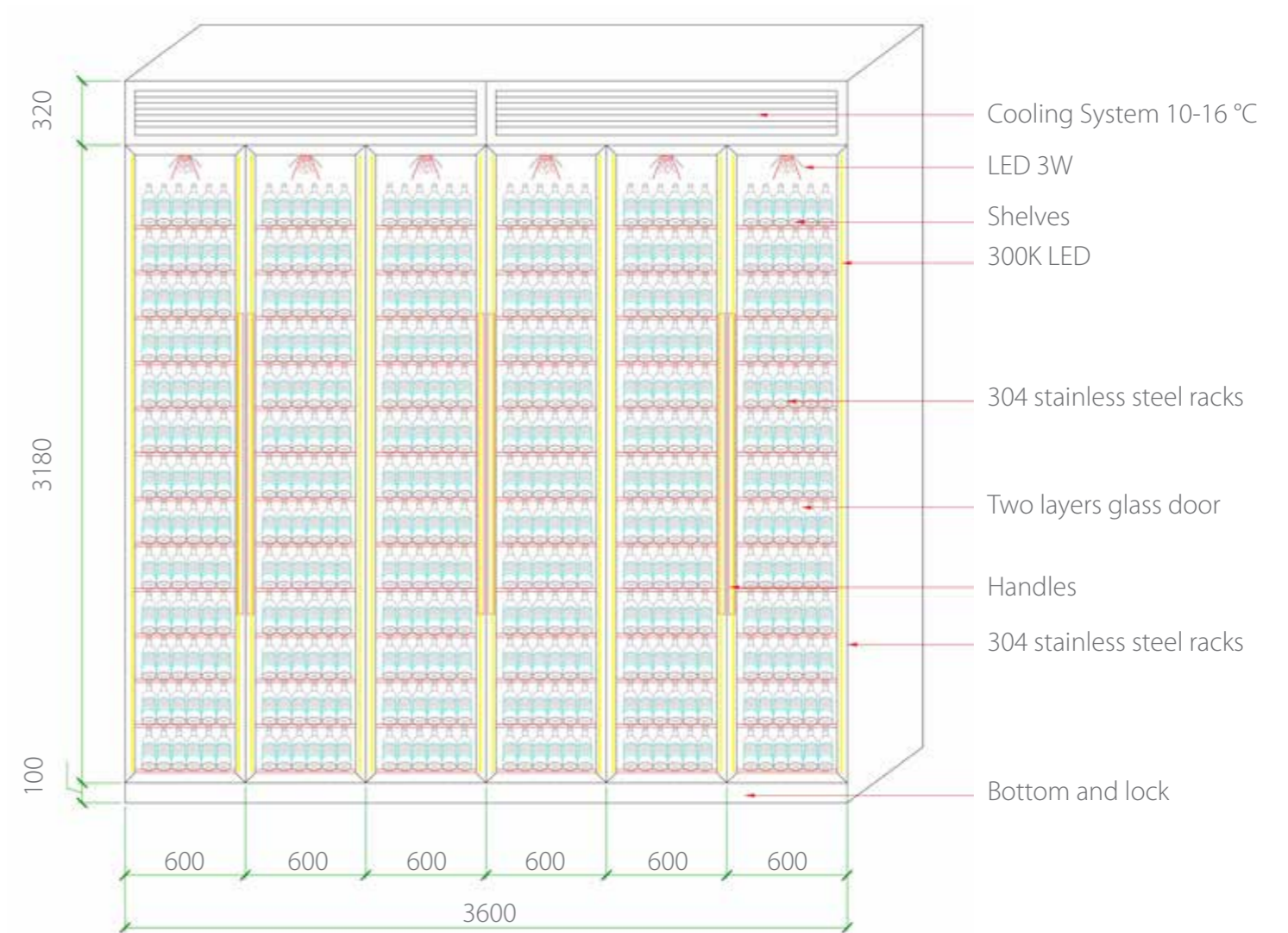



HFC-145SM5, HFC-175SM5, HFC-290SM5



HFC-400DM5, HFC-500DM5, HFC-588DM5, HFC-788DM5



HFC-300GM5, HFC-400GM5, HFC-575GM5

Features

- ◆ HC free refrigerant and foam

Technical Specifications



Specification	Hard Top Freezers							Glass Top Freezers		
	HFC-145SM5	HFC-175SM5	HFC-290SM5	HFC-400DM5	HFC-500DM5	HFC-588DM5	HFC-788DM5	HFC-300GM5	HFC-400GM5	HFC-575GM5
Star Rating	5	5	5	5	5	5	5	5	5	5
Gross Volume (Litres)	102	146	264	383	439	524	734	295	405	575
Dimensions wxdxh (mm)	543x575x875	700x575x875	935x635x905	1235x745x905	1405x745x905	1645x745x905	1860x855x905	1050x650x836	1355x650x836	1690x650x836
Temperature Range	≤-20°C	≤-20°C	≤-20°C	≤-20°C	≤-20°C	≤-20°C	≤-22°C	≤-22°C	≤-20°C	≤-22°C
Power (W)	70	75	240	300	380	380	300	190	200	300
Refrigerent	R600a	R600a	R600a/R290	R290	R290	R290	R290	R290	R290	R290
Lock	Yes	Yes	Yes	Yes	Yes	Yes	Yes	Yes	Yes	Yes
Defrost	Manual	Manual	Manual	Manual	Manual	Manual	Manual	Manual	Manual	Manual
No. of Lids / Doors	1	1	1	2	2	2	2	2	2	2
No. of Baskets	1	1	1	1	1	1	1	3(1Mesh+2 Wire)	3(2Mesh+1 Wire)	2 Wire Mesh Basket+ 2 Wire Basket(6 compartment)
Wheels / Castors	Yes	Yes	Yes	Yes	Yes	Yes	Yes	Yes	Yes	4 universal; 2 Lock Wheel
Certification	BEE	BEE	BEE	BEE	BEE	BEE	BEE	BEE	BEE	BEE

Electricals: 220V/50Hz/1 Phase

Specifications are subject to change without prior notice due to continuous product development



Visi Coolers - Italia Series

The Italia series from Trufrost represents a truly premium range of visi coolers in an elegant black body and a luxe frameless door design. These chic visi coolers are designed to enhance the ambience of any store and help you increase your sales by showing beverage bottles, cans, juice packs and other foodstuff at their very best.

- ◆ A choice of 3 models in 77, 300 and 400 litre capacities
- ◆ LED lighting to enhance the display quality
- ◆ VC 300 Slim Italia comes with a very attractive slim fascia
- ◆ VC 300 Slim Italia & VC 400 Italia models also come with black interiors and black shelves
- ◆ The VC 77 Italia can be paired with a similar looking wine cooler model W 19SZ from Trufrost to complement the wine and beer display in trendy bars.



VC-77 Italia



VC-300 Slim Italia



VC-400 Italia

Visi Coolers - NEU Series

The NEU series from Trufrost is yet another premium range of visi coolers draped in a cool white body and an attractive aluminium alloy door frame. The NEU series visi coolers are designed to provide a pleasing look to any store and help you increase your sales by showing beverage bottles, cans, juice packs and other foodstuff at their very best.

- ◆ A choice of 4 models from 250 – 650 litre capacities
- ◆ LED lighting to enhance the display
- ◆ Attractive aluminium alloy door frame



VC-250 NEU



VC-350 NEU



VC-450 NEU



VC-650 NEU

Technical Specifications - Visi Coolers



Specification	Gross Volume (Litres)	w x d x h (mm)	Temperature Range	Power (w)	Lock	Defrost	No. of Lids / Doors	No. of shelves	Interior Light	Wheels / Castors	No. of Compressors	Refrigerant
VC-77 Italia	70	495x450x670	1 - 9°C	85	Yes	Automatic	1	2	LED light	No	1	R600a
VC-300 Slim Italia	300	420x525x1920	2 - 8°C	170	No	Automatic	1	5	LED light	4 legs	1	R600a
VC-400 Italia	400	575x565x1920	2 - 8°C	220	Yes	Automatic	1	5	LED light	4 legs	1	R600a
VC-250 NEU	250	575x555x1645	0 - 10°C	180	Yes	Automatic	1	4	LED light	4	1	R600a
VC-350 NEU	350	575x610x1710	0 - 10°C	210	Yes	Automatic	1	4	LED light	4	1	R600a
VC-450 NEU	450	615x610x1990	0 - 10°C	240	yes	Manual	1	5	LED light	4	1	R600a
VC-650 NEU	650	655x705x1990	0 - 10°C	280	Yes	Manual	1	5	LED light	4	1	R290

Electricals: 220V/50Hz/1 Phase Specifications are subject to change without prior notice due to continuous product development
 Working condition for open chillers/glass door freezer is class 3 (Room Temp. 25°C and 60%RH)



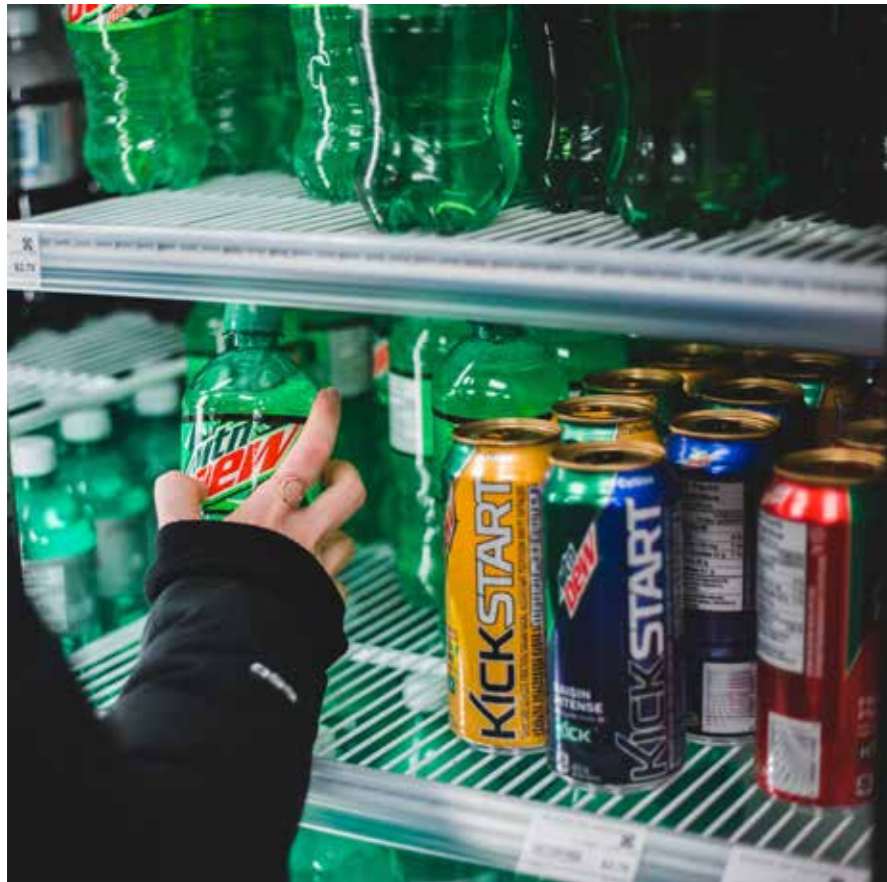

Grab & Go Plug-in Multideck Chillers

The grab & go open multideck chillers from Trufrost offer spectacular display of packaged beverages, sandwiches, confectionery and more. You can choose between 2 models that come with elegant looks with auto-defrost and drainage, LED lighting, night curtain and adjustable shelves.



GG-700



PMD-1310

Key Features

- ◆ Digital controller
- ◆ Finned evaporator
- ◆ Automatic defrost
- ◆ LED light with night curtain
- ◆ Adjustable shelves with price label setting
- ◆ Automatic drain water

Key Features

- ◆ High efficiency and balanced refrigeration system
- ◆ LED lighting in each shelf, model PMD 1310 with daylight white
- ◆ Optimised shelf depth enables more effective displayable volume
- ◆ Night curtain minimizes energy loss
- ◆ Off-cycle defrost reduces the energy consumption
- ◆ Eco friendly R404a refrigerant

Technical Specifications



Model	Dimensions wxdxh (in mm)	No. of Layers (Description)	Volume (Litres)	Temperature Range (°C)	Front Glass	Refrigerant	Power (W)
GG-700	706x717x1500	4 (Base + 3 shelves)	190	3~7	N.A.	R290a	500

Electricals: 220V/50Hz/Single Phase Specifications are subject to change without prior notice due to continuous product development
Working condition for open chillers/glass door freezer is class 3 (Room Temp. 25°C and 60%RH)

Technical Specifications



Model	Dimensions wxdxh (in mm)	Capacity (in Litres)	Temperature (in °C)	Power	Rated Current	Energy consumption kW per day	Refrigerant	Shelves
PMD-1310	1310x660x2000	565L	+2 ~ +8	1300 W	10.5A	38.8	R290a	4

Electricals: 220V/50Hz/Single Phase Specifications are subject to change without prior notice due to continuous product development
Working condition for open chillers/glass door freezer is class 3 (Room Temp. 25°C and 60%RH)

Ice Machines

Trufrost Ice Machines are built around the Trufrost brand promise: best-in-class manufacturing, a wide variety of ice production & storage capacities and above all, reliability. Trufrost Ice Cube Machines and Flake Ice Machines come in capacities ranging from 18 kg to 1000 kg per day and are ideal for use in hotels, restaurants, fast food outlets, bars, coffee shops, clubs, convenience stores, healthcare applications and more.

Trufrost - The Smart Ice Machine

Trufrost ice machines come with a unique self-monitoring feature. The indicator lights in the control panel alert you when it is time to perform normal maintenance or call for service before it becomes an emergency. No wonder, Trufrost is today's most reliable and fool-proof ice system on the market.



Ice Makers

Trufrost Ice Machines present the optimal options for bars, coffee shops and restaurant applications in hotels. Ice machines with self-contained bins can even be placed under the counter and are available in ice production capacities ranging from 25 to 95 kg per day. The modular ice machines come with separate insulated bins and are available in ice production capacities ranging from 207 to 985 kg per day.



IC-25



IC-35BWA, IC-50BWA



IC-100



IC-220
on ISB 150 Bin



IC-300, IC-455
on ISB 125 / ISB 170 Bin



IC-950
on ISB 315 Bin



Technical Specifications - Ice Machines



Model	Rated Capacity / 24 hrs.*	Ice Storage Capacity	Cube Shape / Size	Refrigerant	Electricals	Power (w)	Dimensions wxdxh (mm)	Compatible Storage Bin
IC 25	25 kgs.	6.0 kgs.	Dice / 28*28*23 mm	R404a	220V/50Hz	180	380*470*600	-
IC 35 BWA	30 kgs.	15 kgs.	Dice / 28*28*23 mm	R404a	220V/50Hz	280	500*450*830	-
IC 50 BWA	50 kgs.	18 kgs.	Dice / 28*28*23 mm	R404a	220V/50Hz	320	500*590*830	-
IC 100	98 kgs.	45 kgs.	Dice / 28*28*23 mm	R404a	220V/50Hz	600	660*680*930	-
IC 220	220 kgs.	150 kg	Dice / 28*28*23 mm	R404a	220V/50Hz	850	560*830*1600	ISB-150
IC 350	350 kgs.	220 kg	Dice / 28*28*23 mm	R404a	220V/50Hz	1200	760*830*1600	ISB-220
IC 460	460 kgs.	220 kg	Dice / 28*28*23 mm	R404a	220V/50Hz	1600	760*830*1800	ISB-220
IC 1000	950 kgs.	460 kg	Dice / 28*28*23 mm	R404a	380V/50Hz	4500	1220*930*1980	ISB-460

* At 10°C incoming water and 10°C air temperature

Height & width for IC 220/300/455/950 and IF 300/500/1000 is with the suggested storage bin

Specifications are subject to change without prior notice due to continuous product development

Dice



- ❖ Large cube ice: 28*28*23mm, 15g
- ❖ Cleanest cube ice in the world
- ❖ Crystal clear ice cube
- ❖ Good hardness

Available in models:

IC-35BWA, IC-50BWA, IC-100, IC-220, IC-300, IC-455, IC-950

Bullet Ice



- ❖ Bullet ice size: 38*30*13mm, 12g
- ❖ Not sticky
- ❖ Good hardness
- ❖ Center temperature -10°C

Available in models:

IC-18BWA

Irregular Small Granular Flakes



- ❖ Irregular granular ice
- ❖ Soft taste, chewable
- ❖ Center temperature -5°C
- ❖ Dry and Small, Easy to shape

Available in models:

IF-20, IF-50, IF-70, IF-120, IF-200

Flake Ice



- ❖ Thickness of flake ice 1.5mm~2mm
- ❖ Residual water content 2%
- ❖ Temperature of flake ice: -6°C~-12°C
- ❖ 3 minutes quick ice making

Available in models:

IF-300, IF-500, IF-1000, IF-1500, IF-2000, IF-2500



The art & science of **food preservation**



Team Trufrost has an expertise in design, supply, installation and after-service for your coldroom needs. Having worked extensively in the cold chain industry for over 3 decades, we've devoted ourselves to creating products and solutions that are extremely dependable. Our team has done extensive work with leading brands like Accor, Hilton, Marriott, Taj Hotels, Subway, Sanofi, Johnson & Johnson, Ranbaxy, Dinshaw's, Radisson, Westin, Park Plaza, Haldiram, Ramada, Amul, ITC, Oberoi, Shantha Biotechnics, Radha Regent, Cisco, Nilgiris and many more names.



The Coldroom Experts

Team Trufrost has an expertise in design, supply, installation and after-service for your coldroom needs. Having worked extensively in the cold chain industry for over 3 decades, we've devoted ourselves to creating products and solutions that are extremely dependable. Our team has done extensive work with leading brands like Google, Bahrain International Airport, Hyatt, Hilton, Marriott, Taj Hotels, Leela, Sanofi, Johnson & Johnson, Ranbaxy, Dinshaw's, Radisson, Westin, IBIS, Haldiram, Curefit, Ramada, ITC, Oberoi, Cisco and many more names.



Walk-in Coldrooms

We specialize in preservation & storage of products ranging from hospitality, frozen foods, fresh produce, dairy products, beverages, to medicines & vaccinations and more. Be it small walk-in coolers & freezers, or large refrigerated warehouses, Trufrost Coldrooms are easy to install, use, and maintain, keeping you up and running from the very start.



Key Features - Trufrost Coldrooms

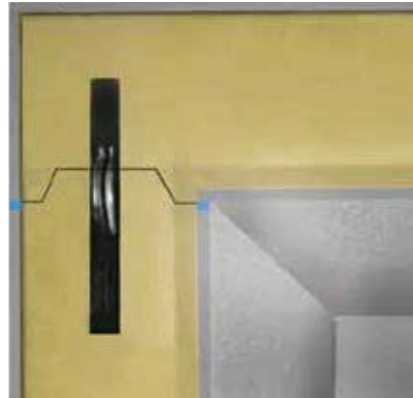

Cam Locking & Gaskets

Our camlocks ensure strong, perfect alignment of all joints. Food-grade PVC gaskets make them neat & leak-proof and are a superior replacement of silicon sealants.



Rounded Corners

Trufrost gives you the option of rounded corner and T-joint on wall to wall, wall to ceiling (only imported) and wall to floor sections that enables easy cleaning of corners and utmost hygiene in your cold room.



Inside & Outside Ramp

Site conditions are often not perfect but you may still need to move in and out of cold rooms frequently. Trufrost custom designed ramps ensure that you cart out your foodstuff on trolleys, unhindered.

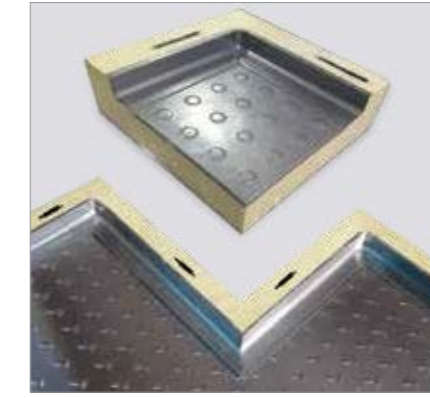

Custom Built Panels

Trufrost PUF Panels can be made to suit your layout design and site conditions. Our sizes are flexible and use L, T and + shape panels to ensure the cold rooms are structurally strong, rivet-free and hygienic.



Sliding Doors

Perfect solution for tight alleys but a wider opening requirement. Trufrost offers heavy duty sliding doors with highly durable, European accessories.



Shelving System

Trufrost offers shelving for cold rooms with option of SS304 or SS201. We offer you optimal storage system to maximise space utilisation in a coldroom to suit different budgets.



Control Panel (with I.O.T.)

Our control panels are designed to maximise the performance of all types of refrigeration systems. Optional features of remote monitoring and BMS compatibility are available.



LED lighting (optional)

Energy saving LED lighting options designed for damp, wet, walk-in coolers or freezers applications are available from Trufrost. We also offer IP65 lighting.



Panel Finishes

Trufrost offers a wide choice of panel finishes to suit any application. We can help you choose the right sheet thickness for each finish depending upon your need.



Pre-Painted White Sheet
0.4/0.5/0.6/0.8/1.0/1.2 mm



PVC Finish.
0.6/0.8/1.0/1.2 mm



Galvanized Sheet.
0.5/0.6/0.8/1.0/1.2 mm



Stucco Aluminum Sheet.
0.5/0.6/0.8/1.0/1.2 mm

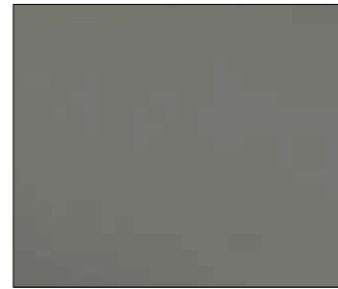

S.S. Sheet (#304)
0.5/0.6/0.8/1.0/1.2 mm

Physical Property of PUF & PIR Panels

PUF Thickness (mm)	Recommended Temp. Degree @ 32°C Ambient Temp.	Weight						Thermal Conductivity 'K' Value W/mK	Thermal Transmittance 'U' Value W/m²K	Thermal Resistance 'R' Value m²K/W	Thermal Transmittance 'U' Value K.Cal/m²K	Thermal Resistance 'R' Value m²K/K.Cal
		Wall & Ceiling		Floor Panel								
		Kg/Sq.ft	Kg./Sq.mtr	Floor Bare Slab		Alu. Checked Floor						
60	+20 to +2	1.5	16	0.25	3	2.5	27	0.022	0.3521	2.84	0.3018	3.31
80	+2 to -8	1.6	17	0.35	4	2.6	28	0.022	0.2679	3.73	0.2296	4.36
100	-8 to -18	1.7	18	0.425	5	2.7	29	0.022	0.2163	4.62	0.1854	5.39
125	-18 to -27	1.85	20	0.525	6	2.85	31	0.022	0.1721	5.81	0.1475	6.78
150	-27 to -50	2	22	0.65	7	3	32	0.022	0.1459	6.85	0.1251	7.99

Insulation Property of PUF & PIR Panels

Panel Thickness (mm)	Thermal Flux (Heat loss per m2 wall area) at different ΔT									
	W/m³					K.Cal/m³				
	60	80	100	125	150	60	80	100	125	150
Temp. Difference °C										
1	0.3521	0.2679	0.2163	0.1721	0.1459	0.3018	0.2296	0.1854	0.1475	0.1251
10	3.5205	2.6797	2.1631	1.7556	1.4596	3.0174	2.2968	1.854	1.5047	1.251
15	5.2808	4.0196	3.2446	2.6335	2.1894	4.5262	3.4452	2.781	2.2572	1.8766
20	7.0411	5.3595	4.3262	3.5113	2.9192	6.0349	4.5936	3.708	3.0095	2.5021
25	8.8014	6.6993	5.4077	4.3891	3.6491	7.5437	5.7419	4.635	3.7619	3.1276
30	10.5617	8.0391	6.4893	5.267	4.3789	9.0524	6.8903	5.562	4.5143	3.7531
35	12.3219	9.379	7.5708	6.1447	5.1087	10.5611	8.0387	6.489	5.2667	4.3786
40	14.0822	10.7189	8.6524	7.0226	5.8384	12.0699	9.1871	7.4159	6.0191	5.0041
45	15.8424	12.0587	9.734	7.9004	6.5682	13.5786	10.3356	8.343	6.7714	5.6296
50	17.6028	13.3986	10.8155	8.7782	7.298	15.0873	11.484	9.2699	7.5238	6.2551
55	19.3631	14.7385	11.8971	9.6561	8.0278	16.5961	12.6324	10.197	8.2762	6.8806
60	21.1239	16.0784	12.9786	10.5339	8.7576	18.1053	13.7808	11.1239	9.0286	7.5062
65	22.8836	17.4182	14.0602	11.4117	9.4874	19.6135	14.9292	12.051	9.781	8.1317
70	24.6439	18.4382	15.1417	12.2896	10.2172	21.1223	15.8034	12.9779	10.5334	8.7572
80	28.1644	21.4377	17.3048	14.0452	11.6769	24.1397	18.3743	14.832	12.0382	10.0082

Wall Drain System

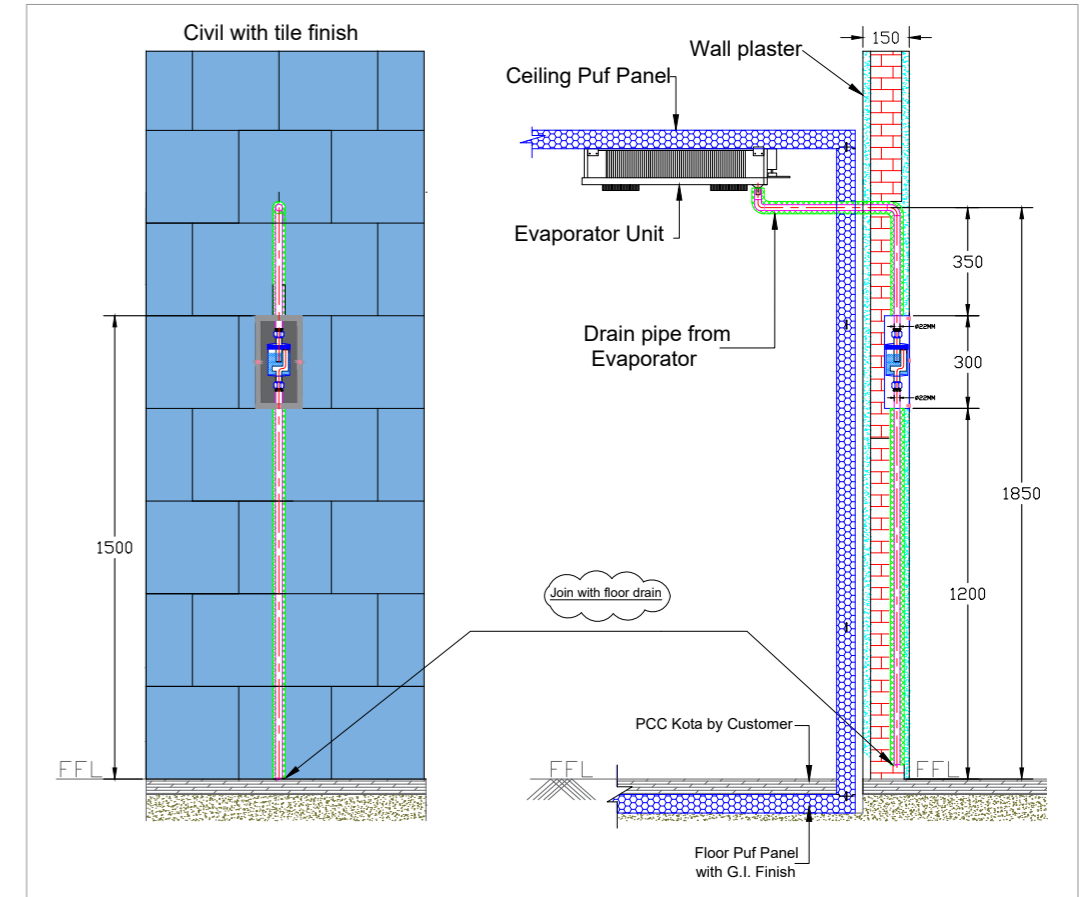
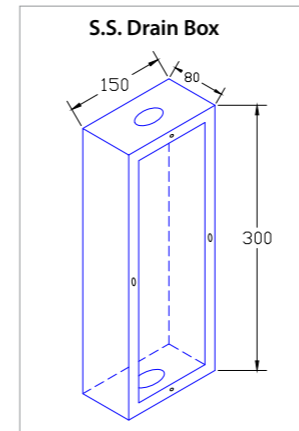
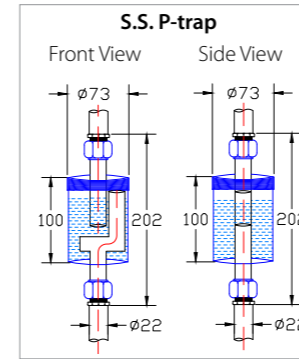

Contemporary ALTRO Safety Floor finish for wet application for premium kitchens



Kota Stone / Tiled Floor finish for wet & rough application for all types of kitchens and processing halls.

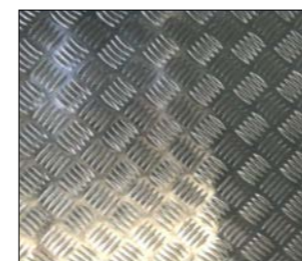

Aluminium Chequered 1.2 to 3.0 mm for Pharma, Ice Cream and any water free applications



Galvanized Sheet. 0.5/0.6/ 0.8/1.0/1.2/1.5 mm for dry applications



S.S. Dimple plates 0.8 to 2.0 mm for all dry type special applications

Floor Finishes

Although often overlooked, coldroom floors play a vital part in ensuring hassle free operation and maintaining a consistent temperature. Trufrost offers a wide choice of floor types to suit any application.

Flush door with accessories

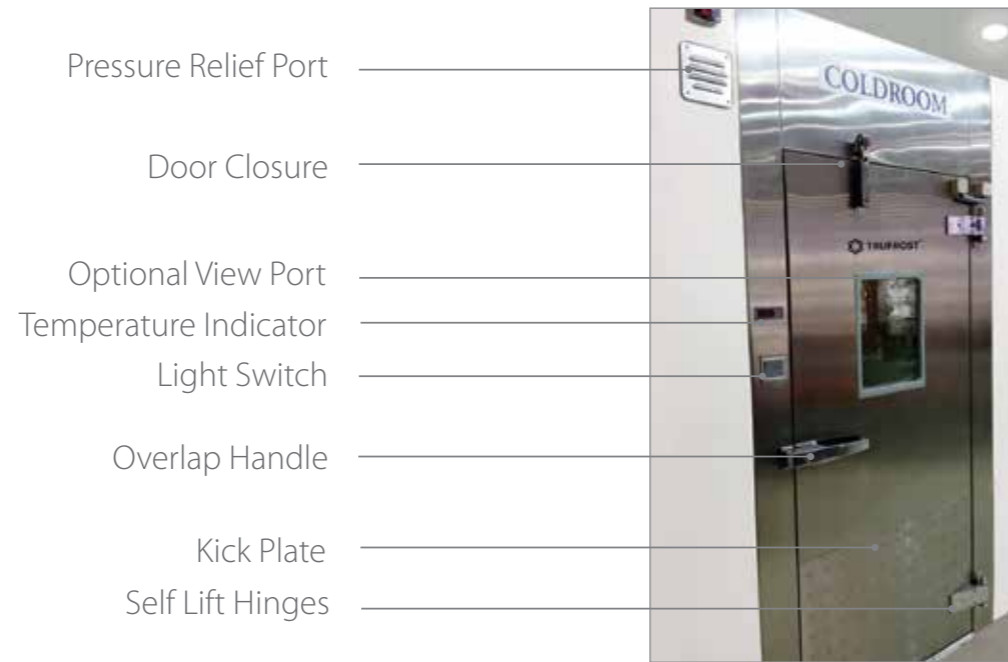

Variety of doors & accessories options

- ◆ Hinge Doors
- ◆ Sliding Doors
- ◆ High Speed Roll-up Doors
- ◆ Flip-flap Doors
- ◆ Sectional Doors
- ◆ Service Doors
- ◆ Dock Seal
- ◆ Dock Levelers

Evaporators

Trufrost is known for high quality evaporator units suited to site requirements, using Sim or low profile, with low energy fans, where available.

Slim

This is a long, slim, compact evaporator for maximising head and storage height below the evaporator and is suitable for the majority of standard commercial coldroom applications.



Cube

These low profile evaporators are ideal for small size cold and freezer rooms. You can use full size shelving to maximise your storage space.



Taper

These are for medium sized cold rooms for all applications with high and low humidity.



Boxer & Hyper

Large commercial, industrial and specialist application type evaporators with high air velocity for greater air throw distances with medium to low temperature and low to high humidity.





Energy-efficient Refrigeration Units

Presenting Trufrost Refrigeration Systems with temperatures ranging from -86°C to +22°C. These world-class Condensing units and Evaporator units are the perfect complement to your Coldroom Panels.

Salient Features :

- ◆ Rack systems with option of inverter compressor
- ◆ Original factory manufactured energy-efficient condensing unit for accurate performance
- ◆ Designed for tropicised conditions (Class T)
- ◆ Stainless steel or pre-painted aluminium evaporators
- ◆ Slim & Taper profile evaporators for space optimisation
- ◆ Silicon heater in drain help in quick installation and easy replacement
- ◆ Option of hermetic scroll & semi-hermetic compressors
- ◆ Option of remote monitoring for BMS compatible HACCP controller



Condensing Units

Trufrost offers a variety of condensing units. Their selection is based on cold room size and usage.

Air Cooled Semi-hermetic: these are generally for small to industrial applications, excessive pipe run or vertical lift distances and speciality blast chilling and freezing applications. They are highly efficient and perform tirelessly.

Water Cooled Semi-hermetic: these are similar to above and use water from cooling tower or chiller to further improve the efficiency.

Reciprocating Hermetic: for standard cold rooms with split type remote unit application. These are economical and easy to install.

Hermetic Scroll: for medium to larger rooms, longer horizontal pipe runs and speciality applications such as blast chilling and medium temperature application.



Air Cooled



Water Cooled



Hermetic Recip/Scroll

Technical Specifications - Refrigeration System

Model No. Cond. Unit	Model No. Evapo. Unit	Refrigeration Capacity BTU/Hr.	Max. Room Volume (CFT)	Max. Room Area with 8'Ht. (Sq.Ft.)	Temp. Range (C)	Max. Loading (Kgs./Day)	Loading Temp. (C)	Ambient (C)	Power Supply (V/Ph/Hz)	Power* Consumption (Kw)	Defrosting (Type)	Approx. weight (Kgs.)
TH-AH-008-21	Slimmer-S2-08-AL	8000	525	65	2 to 6	300	30	38 to 43	230/1/50	1.6	Off-cycle	70
TH-AH-012-21	Slimmer-S3-12-AL	12000	1000	125	2 to 6	580	30	38 to 43	230/1/50	2	Off-cycle	90
TH-AH-015-21	Slimmer-S4-16-AL	15000	1400	175	2 to 6	810	30	38 to 43	230/1/50	2.5	Off-cycle	110
TH-AH-019-23	Slimmer-S5-20-AL	19000	1900	240	2 to 6	1115	30	38 to 43	400/3/50	3	Off-cycle	148
TH-AH-021-23	Boxer-K34-21-AL	21000	2200	275	2 to 6	1278	30	38 to 43	400/3/50	3.4	Off-cycle	150
TH-AH-036-23	Boxer-K44-36-AL	36000	4000	500	2 to 6	2320	30	38 to 43	400/3/50	5.3	Off-cycle	170
TH-AH-041-23	Boxer-K44-42-ALX	41000	4700	580	2 to 6	2700	30	38 to 43	400/3/50	5.8	Off-cycle	180
TH-AS-060-23	Hyper-H44-60-PPX	60000	7000	875	2 to 6	4065	30	38 to 43	400/3/50	7.6	Off-cycle	220
TH-AS-080-43	Hyper-H45-80-PPX	80000	9000	1125	2 to 6	5225	30	38 to 43	400/3/50	9	Off-cycle	250
TL-AH-005-41	Cuber-S2-05E-AL	5000	240	30	-16 to -18	85	-10	38 to 43	230/1/50	1.5	Electric	78
TL-ASH-007-43	Boxer-K23-07E-ALX	7000	800	100	-18 to -22	280	-10	38 to 43	400/3/50	2	Electric	85
TL-ASH-009-43	Boxer-K24-09E-ALX	9000	1200	150	-18 to -22	425	-10	38 to 43	400/3/50	2.6	Electric	88
TL-ASH-012-43	Boxer-K34-12E-AL	12000	1500	188	-18 to -22	525	-10	38 to 43	400/3/50	3.5	Electric	125
TL-ASH-016-43	Boxer-K43-17E-AL	15500	2000	250	-18 to -22	700	-10	38 to 43	400/3/50	4.3	Electric	150
TL-ASH-020-43	Boxer-K44-20E-ALX	20000	3000	375	-18 to -22	1050	-10	38 to 43	400/3/50	6	Electric	190

Basis of Design : (A) Loading will be 50 Kgs / Sq.ft. / day for Chiller room and 30 Kgs / Sq.ft. / day for Freezer room. (B) Door Openings : 3 to 5 / Hr. (C) Refrigerant : R22 / R407C / R404a / R134a for TH range and R-404a for TL range of equipment. (D) Supply Voltage : 200V - 240V for single phase while 400V - 440V for three-phase supply, otherwise use voltage stabiliser. (E) TH range offered for +22°C to +1°C is with Hermetic Danfoss / Emerson / Techemseh compressor, while TL range is offered for -1°C to -86°C with Hermetic Emerson for small capacities and Semi-Hermetic Bitzer / Dorin / Emerson compressors for higher capacities.

Trufrost reserves the right to change the specifications without prior notice



Ecostar Inverter refrigeration system

The new Bitzer Ecostar from Germany comes with inbuilt variable frequency inverter that can reduce your operating cost by up to 30%. This can operate between 25 to 87 Hz frequency and it is 'plug & play'. These are compact, top discharge units that can be kept next to wall, hence space saving. A single system can run upto 6 cold rooms or 4 freezer rooms and is ideal for hotels and warehousing.



Ecolite With capacity control

The Bitzer Ecolite air cooled CDUs from Germany are highly flexible, sustainable and easy to install. These plug & play machines come with smart Bitzer controller allowing simple implementation in the cooling system and constant monitoring of operating parameters and settings. A single system can run upto 6 cold rooms or 4 freezer rooms and is ideal for hotels and banqueting applications.

Bitzer Rack Systems

The Bitzer Multipac & Hyperpac, multi compressor rack system comes with the proven series of new Bitzer Ecoline Semi Hermetic compressors & Screw compressors. They are surprisingly compact, yet solidly built and are known for enhanced performance and reduced pipe work.

Varipac: Addition of an inverter in the rack enhances its efficiency and increases the life of the system.



Combi Ovens



Conveyorised Pizza Ovens



High Speed Ovens



Modular Bakery Ovens



Rotary Rack Ovens



Deck Ovens



Induction Systems



Automatic Coffee Machines



Traditional Coffee Machines



Electric Proofer + Ovens



Convection Ovens



Planetary Mixers



Floor Standing Fryers



Pizza Stone Ovens



Microwave Ovens



Countertop Fryers with Autolift



Dough Sheeters



Bread Slicers



Commercial Blenders



Juice Dispensers



Soft Serve Freezers



Oil Filtration Carts



Steamers



Storage Racks



You may ask for our more detailed catalogues for individual categories or download the same from www.trufrost.com/downloads/.

Is food-waste disposal playing
on your mind?



MagicBox – an innovative on-site food waste solution

Marketed by Trufrost & Butler, the MagicBox simply mimics a natural digestion process and can decompose waste foods within 24 hours. Our engineers often compare the MagicBox food waste aerobic biodigesters to steel stomachs. These machines can easily handle anything that a human can eat such as bread, pasta, fruits, vegetables, and other items commonly seen in the food group.



Key Features

- ◆ Low cost, on-site food waste disposal
- ◆ State-of-the-art technology
- ◆ Carbon footprint reduction
- ◆ Interior-Exterior in SS 304
- ◆ Quiet, clean & odour free
- ◆ Eliminates the spread of bacteria such as salmonella or legionella
- ◆ Simple to operate
- ◆ Minimum power consumption; reduced running costs

How does the MagicBox work?

The Magic Box is designed, manufactured and installed using cutting edge technology in the food waste recycling industry. When food waste enters the MagicBox biodigester, it begins to disappear in just a few hours. This seemingly magical process is actually the work of our MagicFluid and Star Chips. As this special mixture combines together to feast on the food waste, grey water is created as a by-product. This grey water can be safely discharged into the sewage system, creating a circular environmental economy.

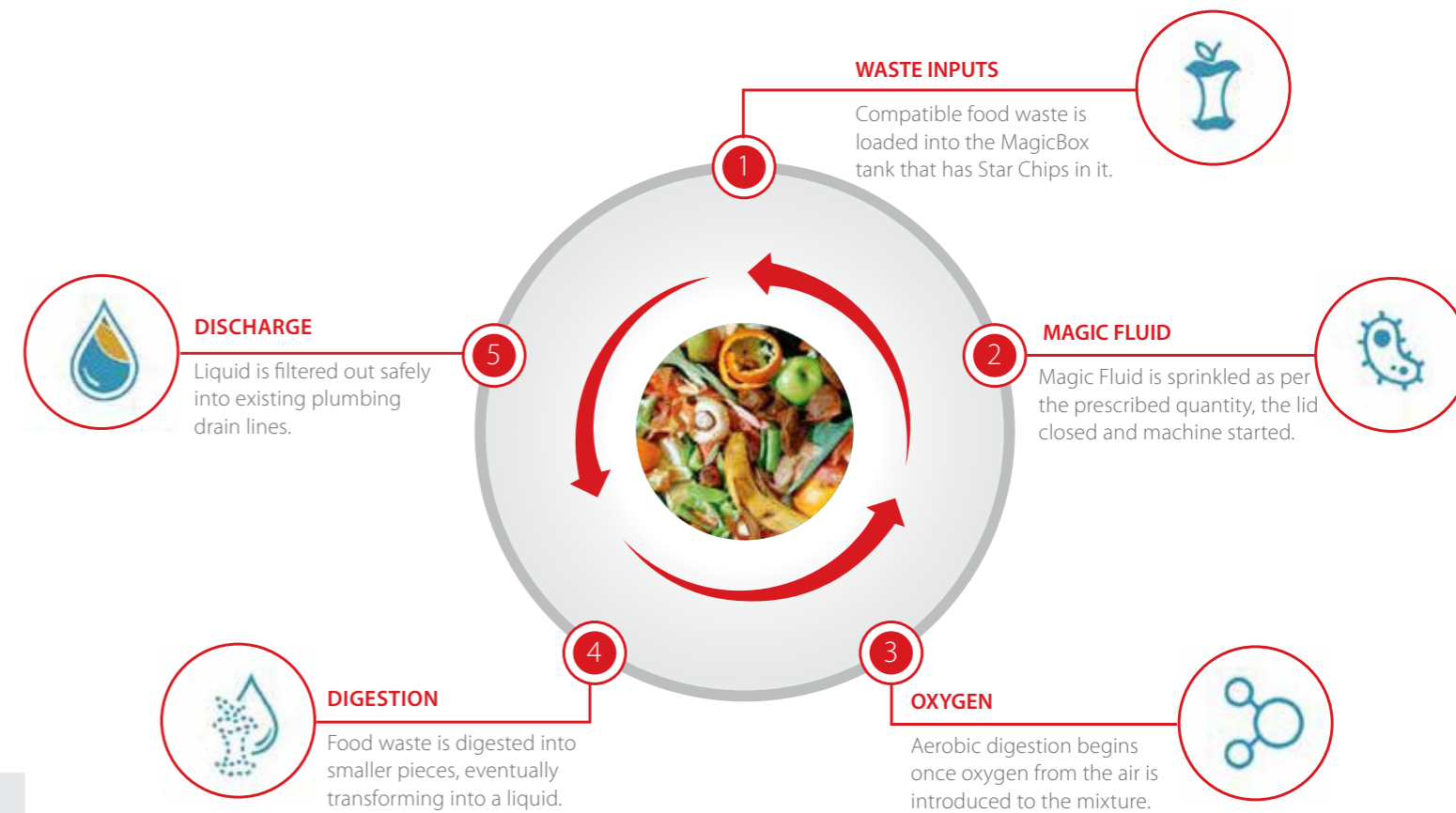

Being an aerobic digester, MagicBox can be installed in virtually any commercial food preparation establishment and is designed to create a waste product that is decomposed enough to be discharged directly into the wastewater system. The filtered grey water can even be used for irrigation. It is a hyperlocal alternative to the traditional truck and bin collection system. We deliver significant savings because we eliminate haulage from the process while significantly reducing the harmful emissions that come with truck traffic.



WBC1-120

WBC2-120

WBC1-240

WBC2-240

Features

- ◆ HC free refrigerant and foam
- ◆ Electronic thermostat and digital LED temperature display for accurate control and easy reading
- ◆ Auto defrosting and auto evaporation of condensation water
- ◆ Insulation 40 mm thickness
- ◆ Self-closing door
- ◆ Magnetic gasket can be replaced without any tools
- ◆ Designed to accommodate 120 litre or 240 litre dustbin
- ◆ EXT.& INT. SS304
- ◆ Built-in unit for WBC1-120 WBC2-120, monoblock unit for WBC1-240 WBC2-240

Technical Specifications



Model	Ext. Dimension WxDxH (mm)	Temperature (°C)	Power Supply
WBC1-120	832x740x970	+2 ~ +8°C	230V/50Hz
WBC2-120	1422x740x970	+2 ~ +8°C	230V/50Hz
WBC1-240	1090x920x1230	+4 ~ +8°C	230V/50Hz
WBC2-240	1810x920x1230	+4 ~ +8°C	230V/50Hz

Specifications are subject to change without prior notice due to continuous product development

Manufacturing & Quality

From advanced technology to diligent quality control, these are the top 7 reasons that make a Trufrost or Butler product a smart choice.



#1. Advanced Technology

Our products are manufactured in the most advanced factories located across the world, many of them highly automated and robotized. While energy efficiency has always been integral to our design process, we continue to bring out new technologies that further improve our systems to be the most efficient in the industry.



#3. Scale

Manufacturing facilities focused on 'scale' allow our factories to invest in advanced technology as well as Research & Development. This, in turn, enables us to remain at the forefront of the technology game and bring cutting edge products to our markets.

#2. Production Lines

Trufrost and Butler products are produced on some of the most automated and well laid out production and assembly lines. Well trained workforce, use of advanced technology and in-process quality control ensure that the final product is cream of the crop.



#4. Quality

Every Trufrost & Butler product complies to the highest standards of quality and consistency. Dedicated testing facilities and laboratories allow us to deliver innovative and cutting edge technologies to the market. Each of our products come with one or more global certifications such as CE, UL, NSF, CCC, CB, ROHS, OHSAS, ETL, ISO 9001, ISO 13485 and ISO 14001 amongst others.









Scan the QR codes given below to download other catalogues for

- | | | |
|---|---------------------------------------|---------|
| 1 | Bakeries
Confectionery | ↓
QR |
| 2 | Commercial Kitchens
Cloud Kitchens | QR |
| 3 | Cafés
Patisseries | QR |
| 4 | Pizzerias
QSRs | QR |
| 5 | Ice Cream Parlours
Juice Bars | QR |
| 6 | Resto-bars
Pubs | QR |
| 7 | Food Retail
Supermarkets | QR |
| 8 | Food Preservation
Cold Storage | QR |



Trufrost & Butler Pvt. Ltd.
 1214 & 1215, 12th Floor, Tower B, Emaar Digital Greens,
 Golf Course Extn. Road, Sector 61, Gurugram - 122011, India
 Tel: +91-124-4246560 Email: info@trufrost.com www.trufrost.com

Andhra/Telangana : 7042027666
 Chennai : 7303890587, 9289143691
 Chhattisgarh : 7303890590
 Coldroom (North): 8448445701, 7303196612
 Coldroom (South): 9319399771, 7303890585
 Delhi/NCR : 8448759200, 7303890582
 Goa : 7303196614

Gujarat : 9319579748
 Assam/North-East : 9319391542, 9667795491
 J & K / Himachal : 9717664894
 Karnataka : 7303890588, 9289143696
 Kerala : 9717664984, 7303890587
 Maharashtra : 7303890586
 Mumbai : 7303196614, 9319579748

Orissa : 7303890590, 9667795491
 Punjab / Haryana : 8448319200, 9319399772
 Rajasthan : 8448759200
 UP : 7303196607
 MP : 7303890582
 Uttarakhand : 8448319200, 9319399772
 West-Bengal/Bihar : 7303890590, 9667795491

Reach-in Cabinets • Undercounter Refrigeration • Blast Freezers • Ice Cubers • Flake Ice Machines • Wine Coolers • Wine Walls • Back Bars • Bottle Coolers • Draught Beer Systems
 Soft Serve Freezers • Granita Dispensers • Juice Dispensers • Hot Chocolate Dispensers • Confectionery Display Cases • Chest Freezers & Coolers • Minibars • Multideck Chillers
 Deli Counters • Visi Coolers • Visi Freezers • Walk-in Coldrooms • Cold Storages • Pre-Coolers • Ultra Low Freezers • Pharmacy Freezers & Coolers • Blood Bank Refrigeration • Mobile Coolers
 Air Sanitisers • Crockery & Cutlery Sterilisers • UV Warm Wipe Sterilisers • Ozone Fruits & Vegetables Disinfectors • Foot Press Water Dispensers



Discover more at
www.trufrost.com